

PRODUCT FEATURES

- Ultrafast Reverse Recovery Time
- Soft Reverse Recovery Characteristics
- Low Reverse Recovery Loss
- High System Power Density
- Popular SOT-227 Package



APPLICATIONS

- Inversion Welder
- Uninterruptible Power Supply
- Plating Power Supply
- Ultrasonic Cleaner and Welder
- Converter & Chopper
- PFC

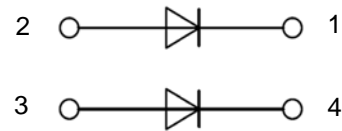

ABSOLUTE MAXIMUM RATINGS($T_C=25^{\circ}C$ unless otherwise specified)

Symbol	Parameter/Test Conditions		Values	Unit
V_R	Maximum D.C. Reverse Voltage		1200	V
V_{RRM}	Maximum Repetitive Reverse Voltage			
$I_{F(AV)}$	Average Forward Current	$T_C=70^{\circ}C$, Per Diode	100	A
		$T_C=70^{\circ}C$, Per Moudle	200	
$I_{F(RMS)}$	RMS Forward Current	$T_C=70^{\circ}C$, Per Diode	141	
I_{FSM}	Non Repetitive Surge Forward Current	$T_J=45^{\circ}C, t=10ms$, Sine, peak value	1400	
		$T_J=45^{\circ}C, t=8.3ms$, Sine, peak value	1540	
I^2t	For Fusing	$T_J=45^{\circ}C, t=10ms$, Sine, peak value	9800	A^2S
		$T_J=45^{\circ}C, t=8.3ms$, Sine, peak value	9840	
P_D	Power Dissipation		312	W
T_J	Junction Temperature		-40 to +150	$^{\circ}C$
T_{STG}	Storage Temperature Range		-40 to +125	$^{\circ}C$
V_{isol}	Isolation Breakdown Voltage	AC, 50Hz(R.M.S), t=1minute	3000	V
Torque	Module to Sink	Recommended (M4)	0.7~1.1	Nm
Torque	Module Electrodes	Recommended (M4)	0.7~1.1	Nm
R_{thJC}	Junction to Case Thermal Resistance(Per Diode)		0.4	$^{\circ}C/W$
Weight			26.5	g

MacMic Science & Technology Co., Ltd.

Add: #18, Hua Shan Zhong Lu, New District, Changzhou City, Jiangsu Province, P. R. of China

MMF2X100J120D

ELECTRICAL CHARACTERISTICS ($T_C=25^\circ\text{C}$ unless otherwise specified)

Symbol	Parameter/Test Conditions	Min.	Typ.	Max.	Unit
I_{RM}	Maximum Reverse Leakage Current	$V_R = 1200\text{V}$		0.5	mA
		$V_R = 1200\text{V}, T_J = 125^\circ\text{C}$		10	
V_F	Forward Voltage	$I_F=100\text{A}$	2.15	2.6	V
		$I_F=100\text{A}, T_J=125^\circ\text{C}$	1.7		
trr	Reverse Recovery Time ($I_F = 1\text{A}, dI_F/dt = -200\text{A}/\mu\text{s}, V_R = 30\text{V}$)		50		ns
trr	Reverse Recovery Time		125		ns
I_{RRM}	Maximum Reverse Recovery Current		9		
trr	Reverse Recovery Time		275		ns
I_{RRM}	Maximum Reverse Recovery Current		19		
trr	Reverse Recovery Time		215		ns
I_{RRM}	Maximum Reverse Recovery Current		76		

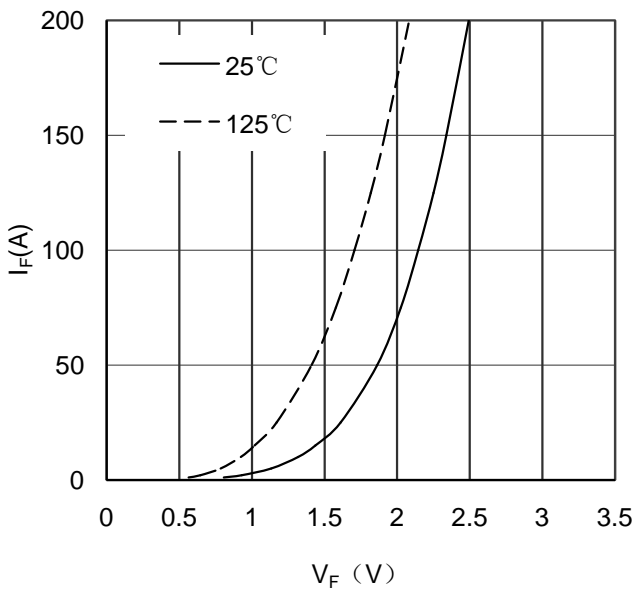

Figure 1. Forward Voltage Drop vs Forward Current

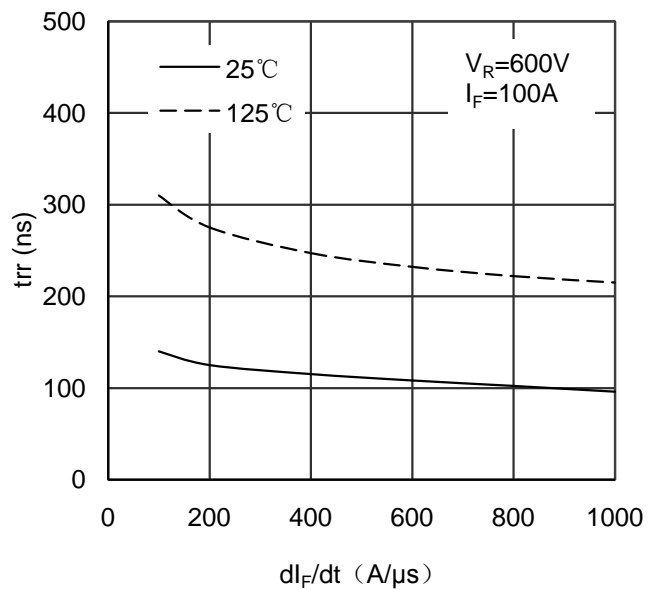

Figure 2. Reverse Recovery Time vs dI_F/dt

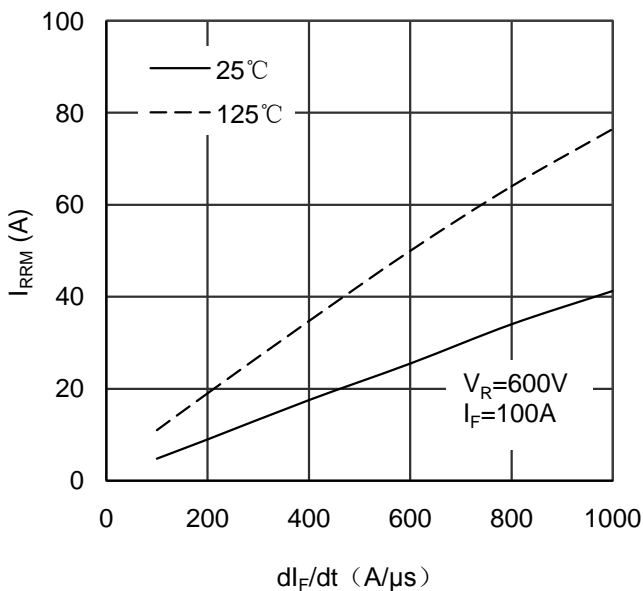

Figure 3. Reverse Recovery Current vs dI_F/dt

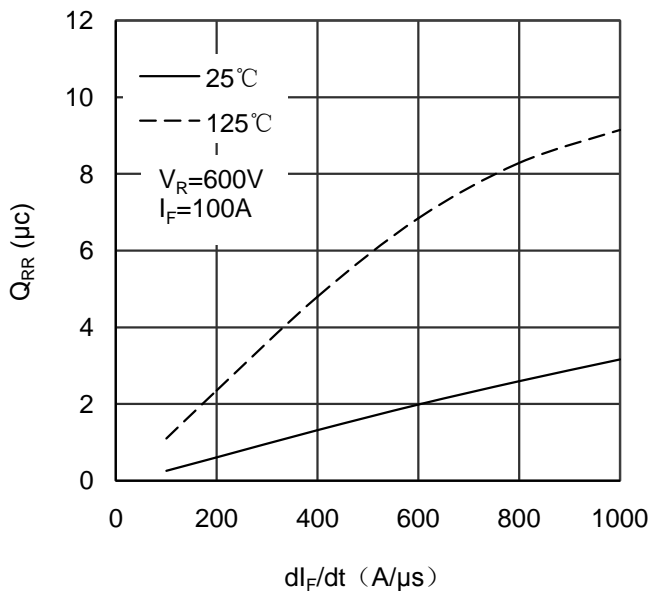

Figure 4. Reverse Recovery Charge vs dI_F/dt

MMF2X100J120D

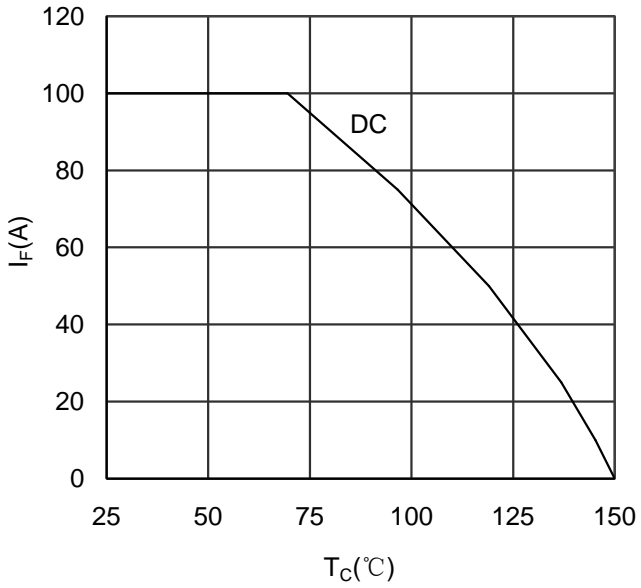

Figure 5. Forward current vs Case temperature

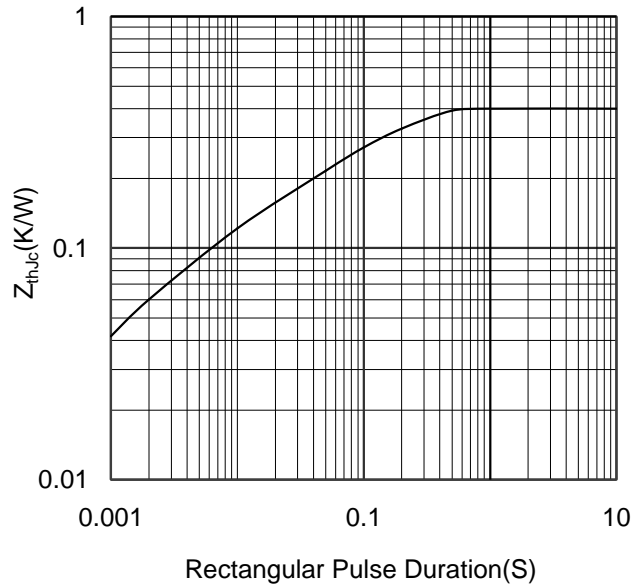
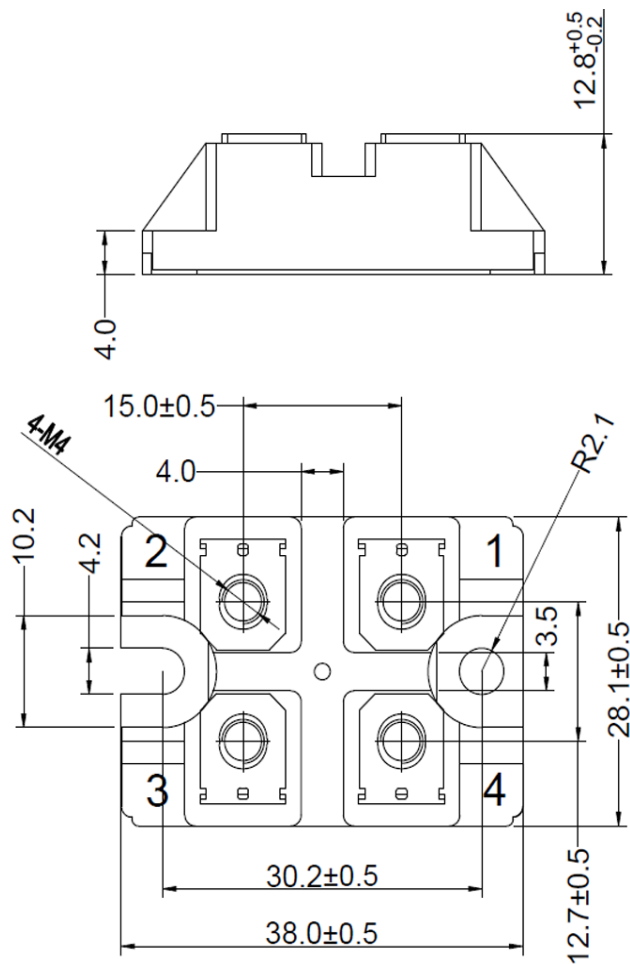

Figure 6. Transient Thermal Impedance



Dimensions in (mm)
Figure 7. Package Outline