

PRODUCT FEATURES

- IGBT³ CHIP(Trench+Field Stop technology)
- High short circuit capability,self limiting short circuit current
- $V_{CE(sat)}$ with positive temperature coefficient
- Fast switching and short tail current
- Free wheeling diodes with fast and soft reverse recovery
- Low switching losses
- Temperature sense included



APPLICATIONS

- High frequency switching application
- Medical applications
- Motion/servo control
- UPS systems

IGBT-inverter

ABSOLUTE MAXIMUM RATINGS($T_C=25^{\circ}C$ unless otherwise specified)

Symbol	Parameter/Test Conditions		Values	Unit
V_{CES}	Collector Emitter Voltage	$T_J=25^{\circ}C$	600	V
V_{GES}	Gate Emitter Voltage		± 20	
I_C	DC Collector Current	$T_C=25^{\circ}C, T_{Jmax}=175^{\circ}C$	95	A
		$T_C=70^{\circ}C, T_{Jmax}=175^{\circ}C$	75	
I_{CM}	Repetitive Peak Collector Current	$t_p=1ms$	150	
P_{tot}	Power Dissipation Per IGBT	$T_C=25^{\circ}C, T_{Jmax}=175^{\circ}C$	250	W

Diode-inverter

ABSOLUTE MAXIMUM RATINGS ($T_C=25^{\circ}C$ unless otherwise specified)

Symbol	Parameter/Test Conditions		Values	Unit
V_{RRM}	Repetitive Reverse Voltage	$T_J=25^{\circ}C$	600	V
$I_{F(AV)}$	Average Forward Current		75	A
I_{FRM}	Repetitive Peak Forward Current	$t_p=1ms$	150	
I^2t		$T_J=125^{\circ}C, t=10ms, V_R=0V$	660	A ² S

MacMic Science & Technology Co., Ltd.

Add: #18, Hua Shan Zhong Lu, New District, Changzhou City, Jiangsu Province, P. R. of China

MMG75HB060H6EN

IGBT-inverter

ELECTRICAL CHARACTERISTICS ($T_C=25^\circ\text{C}$ unless otherwise specified)

Symbol	Parameter/Test Conditions		Min.	Typ.	Max.	Unit
$V_{GE(th)}$	Gate Emitter Threshold Voltage	$V_{CE}=V_{GE}, I_C=1.2\text{mA}$	4.9	5.8	6.5	V
$V_{CE(sat)}$	Collector Emitter Saturation Voltage	$I_C=75\text{A}, V_{GE}=15\text{V}, T_J=25^\circ\text{C}$		1.45	1.9	
		$I_C=75\text{A}, V_{GE}=15\text{V}, T_J=125^\circ\text{C}$		1.6		
I_{CES}	Collector Leakage Current	$V_{CE}=600\text{V}, V_{GE}=0\text{V}, T_J=25^\circ\text{C}$			1	mA
		$V_{CE}=600\text{V}, V_{GE}=0\text{V}, T_J=125^\circ\text{C}$			5	mA
I_{GES}	Gate Leakage Current	$V_{CE}=0\text{V}, V_{GE}=\pm 15\text{V}, T_J=25^\circ\text{C}$	-400		400	nA
R_{gint}	Integrated Gate Resistor			0		Ω
Q_g	Gate Charge	$V_{CE}=300\text{V}, I_C=75\text{A}, V_{GE}=\pm 15\text{V}$		0.8		μC
C_{ies}	Input Capacitance	$V_{CE}=25\text{V}, V_{GE}=0\text{V}, f=1\text{MHz}$		4.6		nF
C_{res}	Reverse Transfer Capacitance				145	
$t_{d(on)}$	Turn on Delay Time	$V_{CC}=300\text{V}, I_C=75\text{A}$ $R_G=5.1\Omega,$ $V_{GE}=\pm 15\text{V},$ Inductive Load	$T_J=25^\circ\text{C}$		25	ns
			$T_J=125^\circ\text{C}$		25	ns
t_r	Rise Time	$V_{GE}=\pm 15\text{V},$ Inductive Load	$T_J=25^\circ\text{C}$		20	ns
			$T_J=125^\circ\text{C}$		20	ns
$t_{d(off)}$	Turn off Delay Time	$V_{CC}=300\text{V}, I_C=75\text{A}$ $R_G=5.1\Omega,$ $V_{GE}=\pm 15\text{V},$ Inductive Load	$T_J=25^\circ\text{C}$		210	ns
			$T_J=125^\circ\text{C}$		240	ns
t_f	Fall Time	$V_{GE}=\pm 15\text{V},$ Inductive Load	$T_J=25^\circ\text{C}$		60	ns
			$T_J=125^\circ\text{C}$		70	ns
E_{on}	Turn on Energy	$V_{CC}=300\text{V}, I_C=75\text{A}$ $R_G=5.1\Omega,$ $V_{GE}=\pm 15\text{V},$ Inductive Load	$T_J=25^\circ\text{C}$		0.35	mJ
			$T_J=125^\circ\text{C}$		0.5	mJ
E_{off}	Turn off Energy	$V_{GE}=\pm 15\text{V},$ Inductive Load	$T_J=25^\circ\text{C}$		2.4	mJ
			$T_J=125^\circ\text{C}$		2.8	mJ
I_{SC}	Short Circuit Current	$tp_{sc}\leq 6\mu\text{S}, V_{GE}=15\text{V}$ $T_J=125^\circ\text{C}, V_{CC}=360\text{V}$		380		A
R_{thJC}	Junction to Case Thermal Resistance (Per IGBT)				0.6	K /W

Diode-inverter

ELECTRICAL CHARACTERISTICS ($T_C=25^\circ\text{C}$ unless otherwise specified)

Symbol	Parameter/Test Conditions		Min.	Typ.	Max.	Unit
V_F	Forward Voltage	$I_F=75\text{A}, V_{GE}=0\text{V}, T_J=25^\circ\text{C}$		1.55	1.95	V
		$I_F=75\text{A}, V_{GE}=0\text{V}, T_J=125^\circ\text{C}$		1.50		
t_{rr}	Reverse Recovery Time	$I_F=75\text{A}, V_R=300\text{V}$		120		ns
I_{RRM}	Max. Reverse Recovery Current	$di_F/dt=-4000\text{A}/\mu\text{s}$		115		A
Q_{RR}	Reverse Recovery Charge	$T_J=125^\circ\text{C}$		6		μC
E_{rec}	Reverse Recovery Energy			1.5		mJ
R_{thJCD}	Junction to Case Thermal Resistance (Per Diode)				0.95	K /W

MMG75HB060H6EN

NTC CHARACTERISTICS ($T_C=25^\circ\text{C}$ unless otherwise specified)

Symbol	Parameter/Test Conditions	Min.	Typ.	Max.	Unit
R_{25}	Resistance $T_C = 25^\circ\text{C}$		5		$\text{K}\Omega$
$B_{25/50}$	$R_2 = R_{25} \exp [B_{25/50}(1/T_2 - 1/(298.15 \text{ K}))]$		3375		K

MODULE CHARACTERISTICS ($T_C=25^\circ\text{C}$ unless otherwise specified)

Symbol	Parameter/Test Conditions	Values	Unit	
T_{Jmax}	Max. Junction Temperature	175	$^\circ\text{C}$	
T_{Jop}	Operating Temperature	-40~150		
T_{stg}	Storage Temperature	-40~125		
V_{isol}	Isolation Breakdown Voltage	AC, 50Hz(R.M.S), t=1minute	3000	V
Torque	to heatsink	Recommended (M5)	2.5~5	Nm
	to terminal	Recommended (M6)	3~5	Nm
Weight			200	g

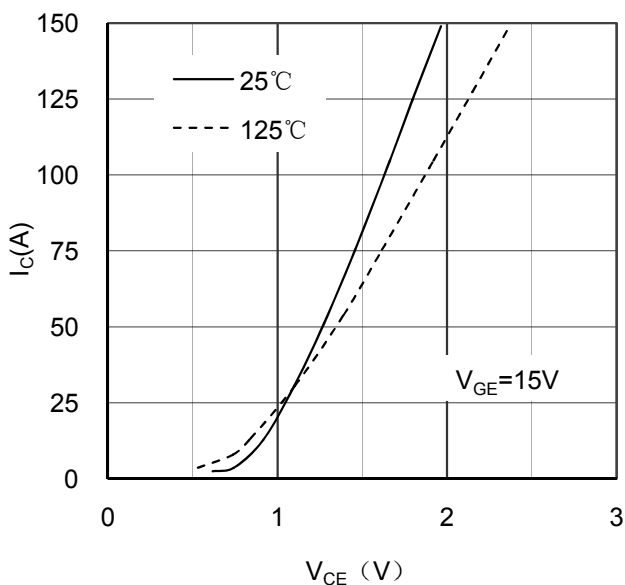

Figure 1. Typical Output Characteristics IGBT-inverter

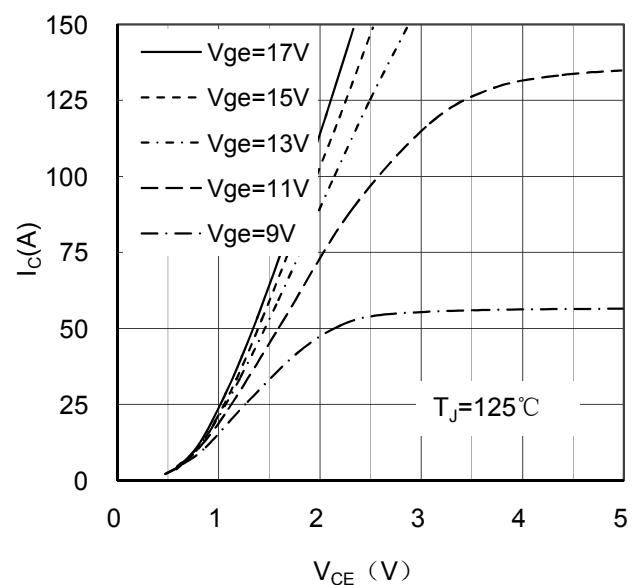

Figure 2. Typical Output Characteristics IGBT-inverter

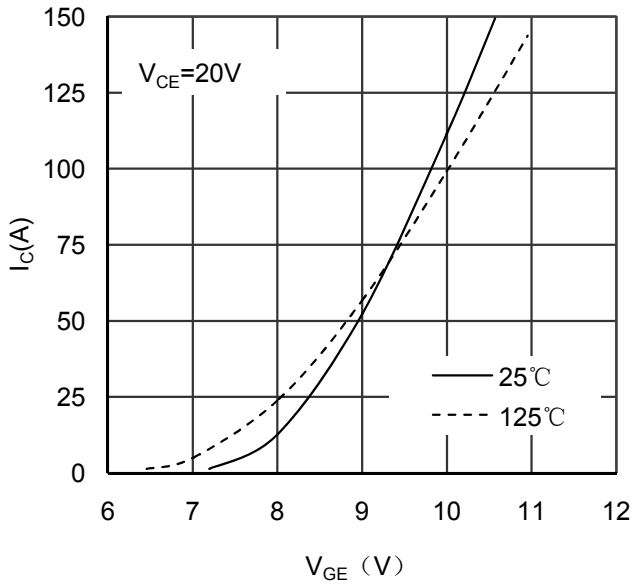

Figure 3. Typical Transfer characteristics IGBT-inverter

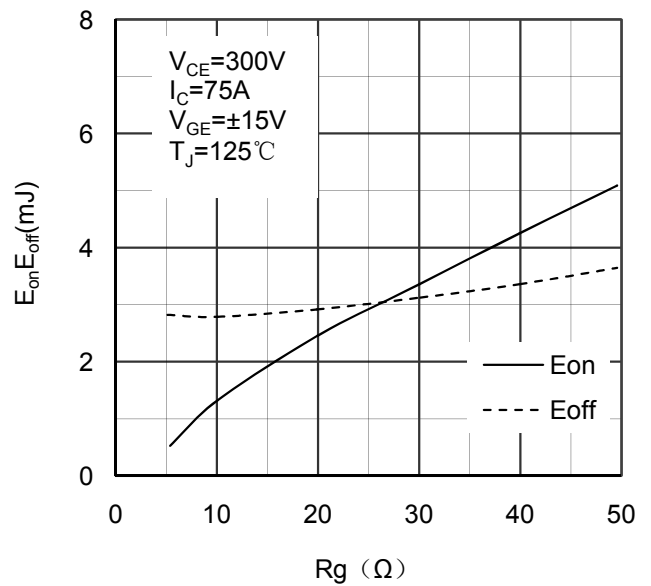

Figure 4. Switching Energy vs Gate Resistor IGBT-inverter

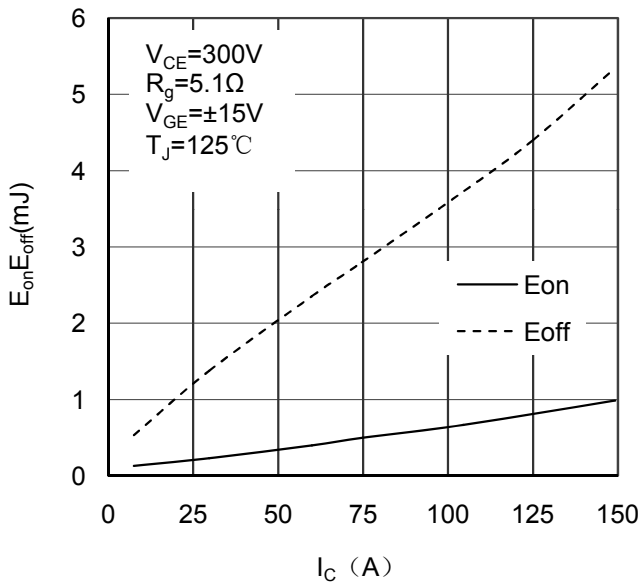

Figure 5. Switching Energy vs Collector Current IGBT-inverter

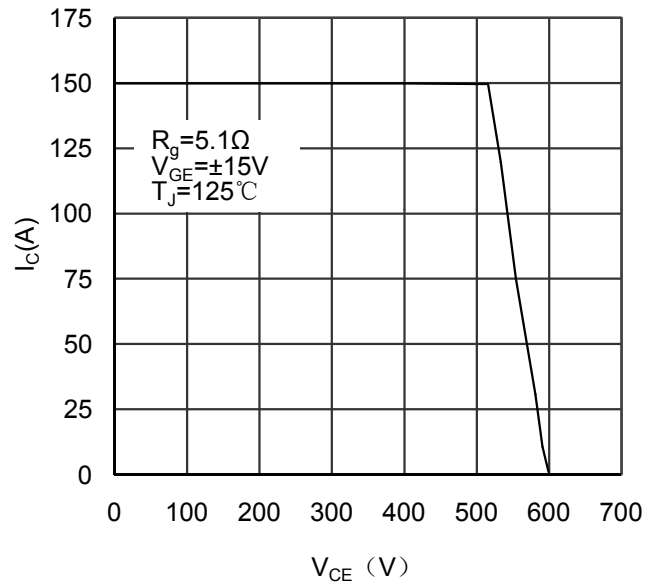

Figure 6. Reverse Biased Safe Operating Area IGBT-inverter

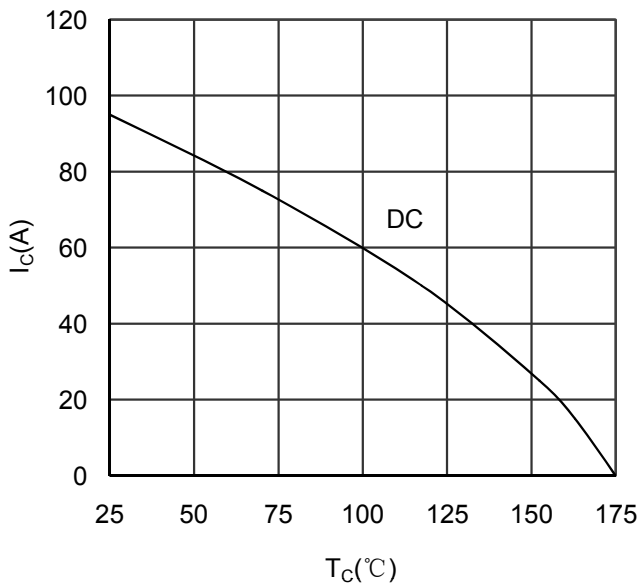

Figure 7. Collector Current vs Case temperature IGBT-inverter

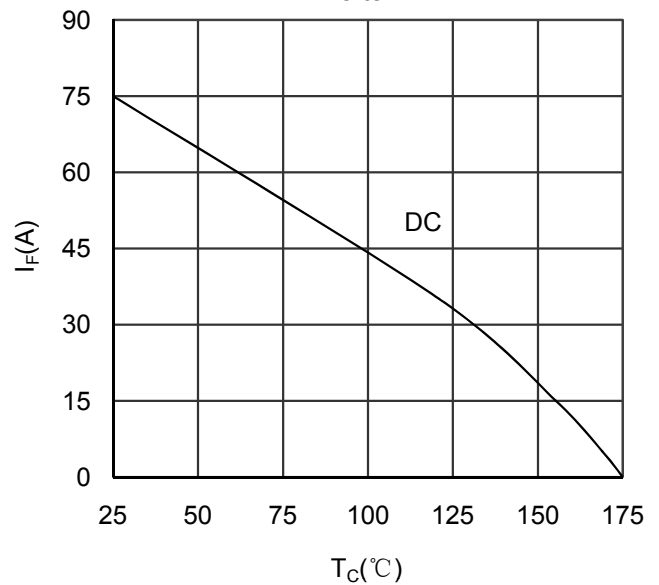

Figure 8. Forward current vs Case temperature Diode-inverter

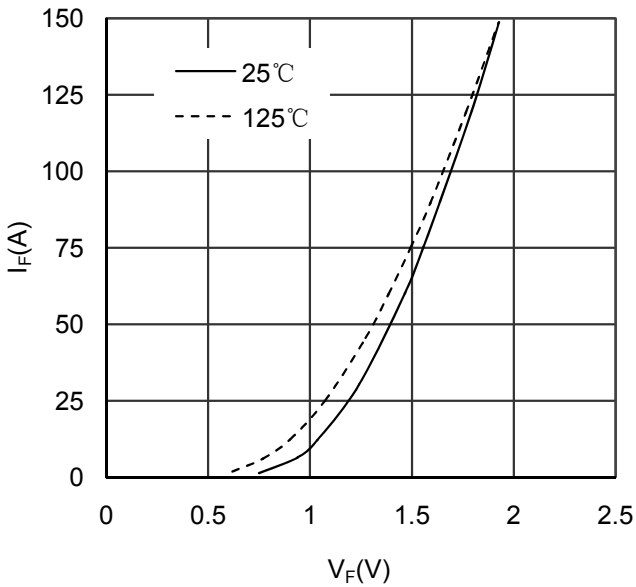

Figure 9. Diode Forward Characteristics Diode -inverter

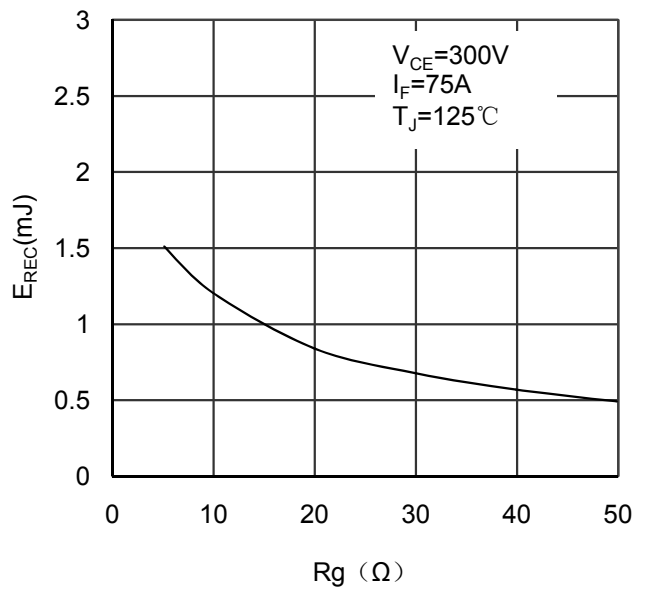

Figure 10. Switching Energy vs Gate Resistor Diode - inverter

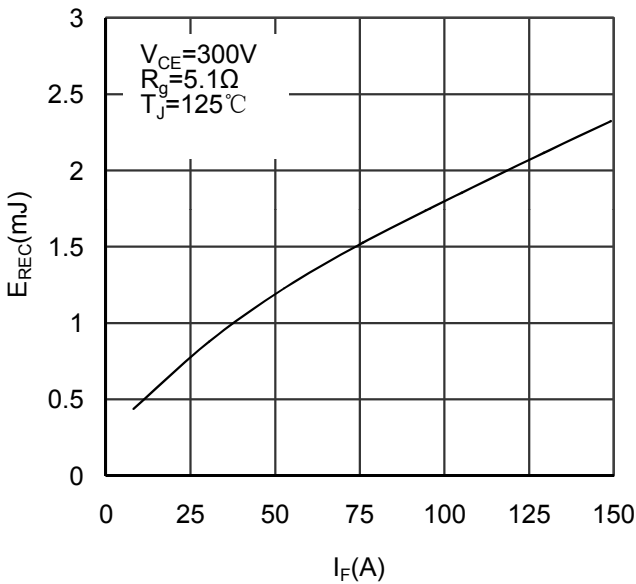

Figure 11. Switching Energy vs Forward Current Diode- inverter

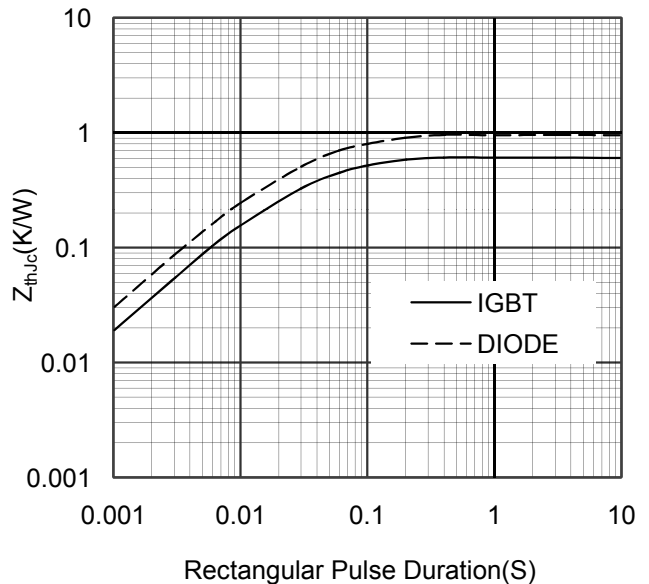

Figure 12. Transient Thermal Impedance of Diode and IGBT-inverter

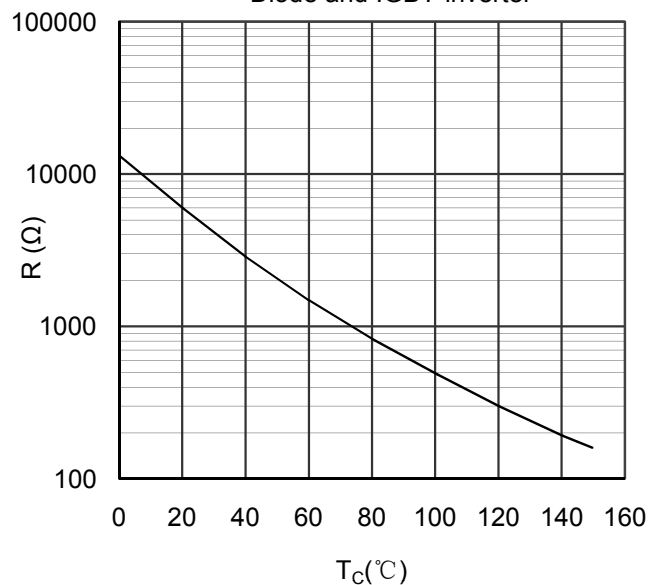

Figure 13. NTC Characteristics

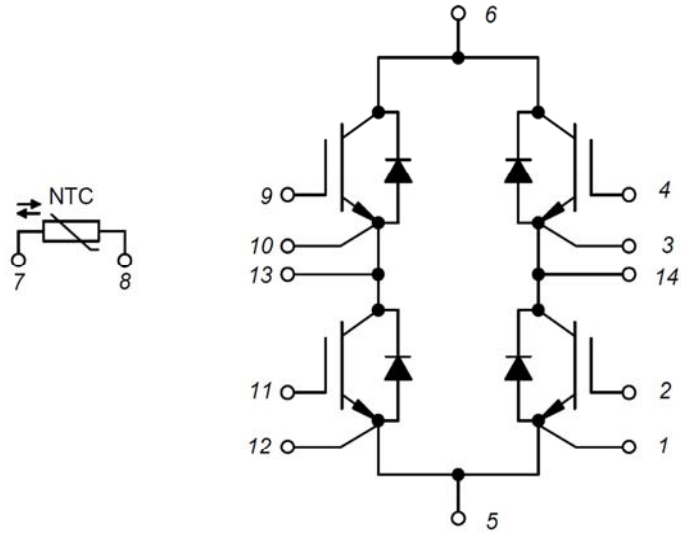
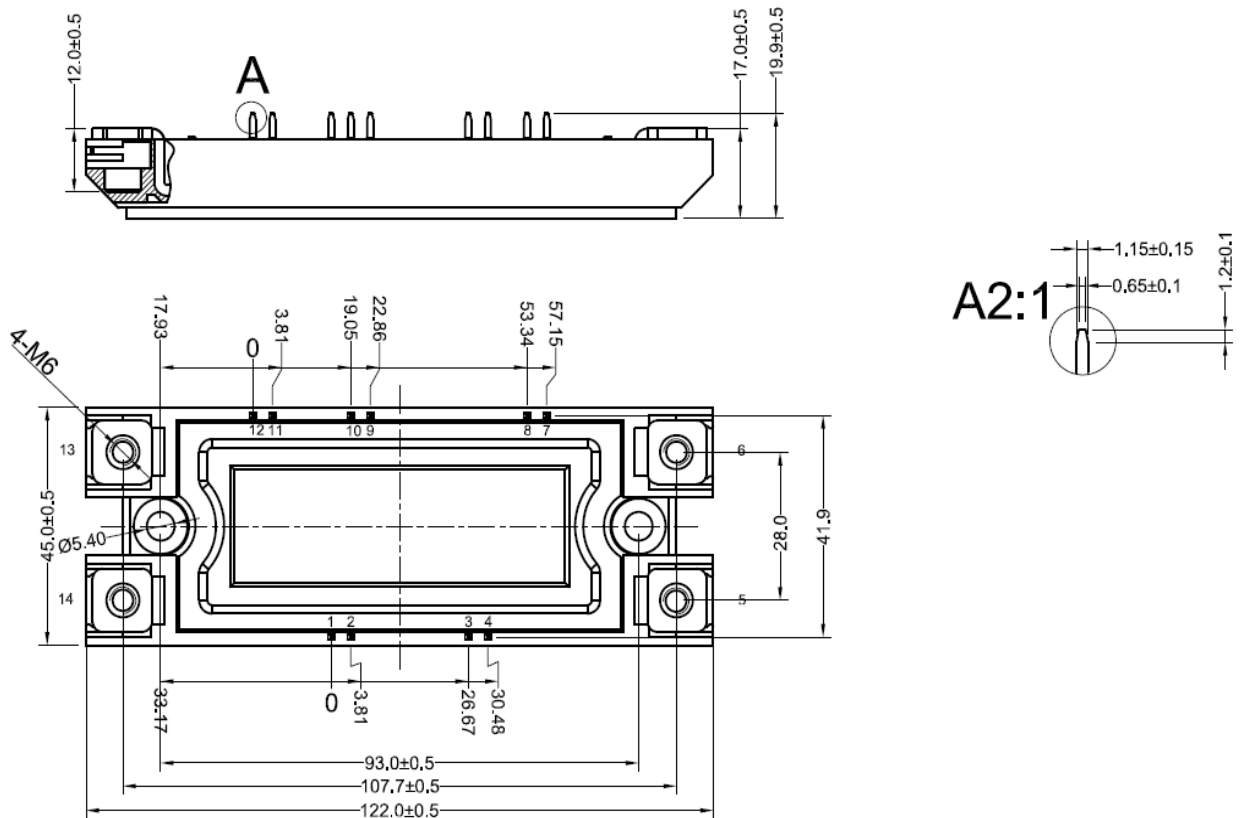

Figure 14. Circuit Diagram



Dimensions in (mm)
Figure 15. Package Outline