



MACMIC

December 2011

PRELIMINARY

MMG400D120UK6HN

1200V 400A IGBT Module

RoHS Compliant

FEATURES

- High short circuit capability, self limiting short circuit current
- IGBT CHIP(T4 Fast Trench+Field Stop technology)
- $V_{CE(sat)}$ with positive temperature coefficient
- Fast switching and short tail current
- Free wheeling diodes with fast and soft reverse recovery
- Low switching losses
- $T_{vj\ max} = 175^{\circ}C$



APPLICATIONS

- High frequency switching application
- Medical applications
- Motion/servo control
- UPS systems

ABSOLUTE MAXIMUM RATINGS

$T_c=25^{\circ}C$ unless otherwise specified

Symbol	Parameter	Test Conditions	Values	Unit
IGBT				
V_{CES}	Collector - Emitter Voltage	$T_{vj}=25^{\circ}C$	1200	V
V_{GES}	Gate - Emitter Voltage		± 20	V
I_c	DC Collector Current	$T_c=25^{\circ}C$	600	A
		$T_c=80^{\circ}C$	400	A
I_{CM}	Repetitive Peak Collector Current	$t_p=1ms$	800	A
P_{tot}	Power Dissipation Per IGBT		2100	W
Diode				
V_{RRM}	Repetitive Reverse Voltage	$T_{vj}=25^{\circ}C$	1200	V
$I_{F(AV)}$	Average Forward Current	$T_c=25^{\circ}C$	600	A
		$T_c=80^{\circ}C$	400	A
I_{FRM}	Repetitive Peak Forward Current	$t_p=1ms$	800	A
I^2t		$T_{vj} = 125^{\circ}C, t=10ms, V_R=0V$	25000	A^2s

MMG400D120UK6HN

ELECTRICAL AND THERMAL CHARACTERISTICS $T_c=25^\circ\text{C}$ unless otherwise specified

Symbol	Parameter	Test Conditions	Min.	Typ.	Max.	Unit
IGBT						
$V_{GE(th)}$	Gate - Emitter Threshold Voltage	$V_{CE}=V_{GE}, I_C=16\text{mA}$	5.4	6	6.5	V
$V_{CE(sat)}$	Collector - Emitter Saturation Voltage	$I_C=400\text{A}, V_{GE}=15\text{V}, T_{Vj}=25^\circ\text{C}$		2.1	2.5	V
		$I_C=400\text{A}, V_{GE}=15\text{V}, T_{Vj}=125^\circ\text{C}$		2.5		V
I_{CES}	Collector Leakage Current	$V_{CE}=1200\text{V}, V_{GE}=0\text{V}, T_{Vj}=25^\circ\text{C}$			2	mA
		$V_{CE}=1200\text{V}, V_{GE}=0\text{V}, T_{Vj}=125^\circ\text{C}$			10	mA
I_{GES}	Gate Leakage Current	$V_{CE}=0\text{V}, V_{GE} \pm 15\text{V}, T_{Vj}=125^\circ\text{C}$	-400		400	nA
R_{Gint}	Integrated Gate Resistor			1.9		Ω
Q_g	Gate Charge	$V_{CE}=600\text{V}, I_C=400\text{A}, V_{GE}=15\text{V}$		1.9		μC
C_{ies}	Input Capacitance	$V_{CE}=25\text{V}, V_{GE}=0\text{V}, f=1\text{MHz}$		25		nF
C_{res}	Reverse Transfer Capacitance				1.4	
$t_{d(on)}$	Turn - on Delay Time	$V_{CC}=600\text{V}, I_C=400\text{A},$ $R_G = 1.8 \Omega,$ $V_{GE} = \pm 15\text{V},$ Inductive Load	$T_{Vj} = 25^\circ\text{C}$	170		ns
			$T_{Vj} = 125^\circ\text{C}$	180		ns
			$T_{Vj} = 150^\circ\text{C}$	190		ns
t_r	Rise Time		$T_{Vj} = 25^\circ\text{C}$	75		ns
			$T_{Vj} = 125^\circ\text{C}$	85		ns
			$T_{Vj} = 150^\circ\text{C}$	90		ns
$t_{d(off)}$	Turn - off Delay Time	$V_{CC}=600\text{V}, I_C=400\text{A},$ $R_G = 1.8 \Omega,$ $V_{GE} = \pm 15\text{V},$ Inductive Load	$T_{Vj} = 25^\circ\text{C}$	440		ns
			$T_{Vj} = 125^\circ\text{C}$	490		ns
			$T_{Vj} = 150^\circ\text{C}$	520		ns
t_f	Fall Time		$T_{Vj} = 25^\circ\text{C}$	45		ns
			$T_{Vj} = 125^\circ\text{C}$	65		ns
			$T_{Vj} = 150^\circ\text{C}$	75		ns
E_{on}	Turn - on Energy	$V_{CC}=600\text{V}, I_C=400\text{A},$ $R_G = 1.8 \Omega,$ $V_{GE} = \pm 15\text{V},$ Inductive Load	$T_{Vj} = 125^\circ\text{C}$	52		mJ
			$T_{Vj} = 150^\circ\text{C}$	58		mJ
E_{off}	Turn - off Energy		$T_{Vj} = 125^\circ\text{C}$	22		mJ
			$T_{Vj} = 150^\circ\text{C}$	24		mJ
I_{sc}	Short Circuit Current	$t_{psc} \leq 10\mu\text{s}, V_{GE}=15\text{V}$ $T_{Vj}=125^\circ\text{C}, V_{CC}=600\text{V}$		1600		A
R_{thJC}	Junction-to-Case Thermal Resistance (Per IGBT)				0.07	K /W
Diode						
V_F	Forward Voltage	$I_F=400\text{A}, V_{GE}=0\text{V}, T_{Vj} = 25^\circ\text{C}$		1.65		V
		$I_F=400\text{A}, V_{GE}=0\text{V}, T_{Vj} = 125^\circ\text{C}$		1.65		V
t_{rr}	Reverse Recovery Time	$I_F=400\text{A}, V_R=600\text{V}$		500		ns
I_{RRM}	Max. Reverse Recovery Current	$di_F/dt=-4000\text{A}/\mu\text{s}$		290		A
E_{rec}	Reverse Recovery Energy	$T_{Vj} = 125^\circ\text{C}$		31		mJ
R_{thJCD}	Junction-to-Case Thermal Resistance (Per Diode)				0.12	K /W

MMG400D120UK6HN

MODULE CHARACTERISTICS

$T_C=25^\circ\text{C}$ unless otherwise specified

Symbol	Parameter	Test Conditions	Min.	Typ.	Max.	Unit
$T_{vj\ max}$	Max. Junction Temperature				175	$^\circ\text{C}$
$T_{vj\ op}$	Operating Temperature		-40		150	$^\circ\text{C}$
T_{stg}	Storage Temperature		-40		125	$^\circ\text{C}$
V_{isol}	Insulation Test Voltage	AC, $t=1\text{min}$		3000		V
CTI	Comparative Tracking Index		350			
Torque	Module-to-Sink	Recommended (M6)	3		5	$\text{N}\cdot\text{m}$
Torque	Module Electrodes	Recommended (M6)	2.5		5	$\text{N}\cdot\text{m}$
Weight				300		g

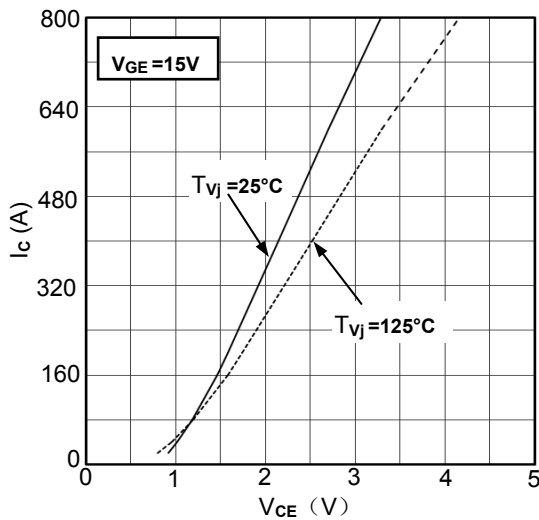

Figure1. Typical Output Characteristics

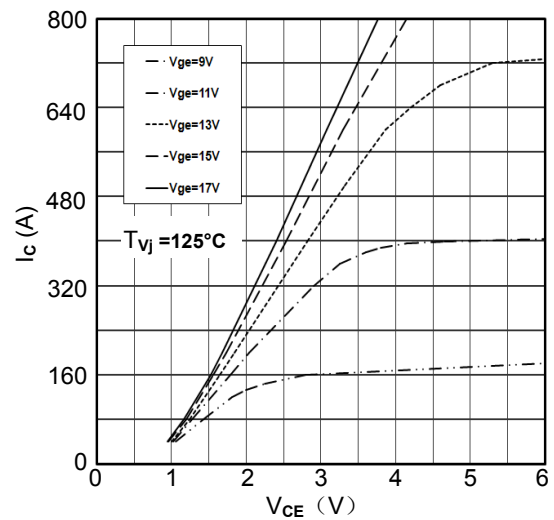

Figure2. Typical Output Characteristics

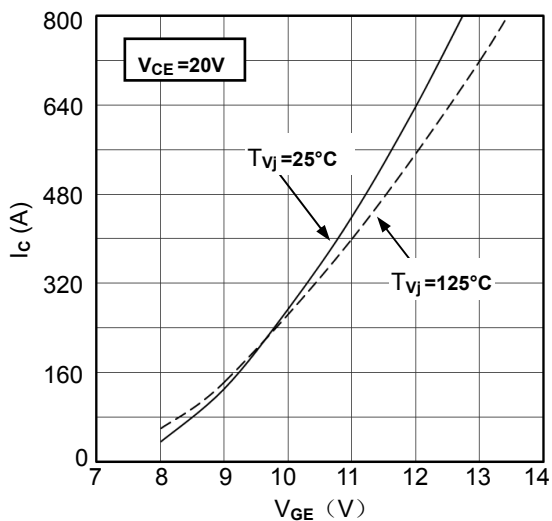

Figure3. Typical Transfer characteristics

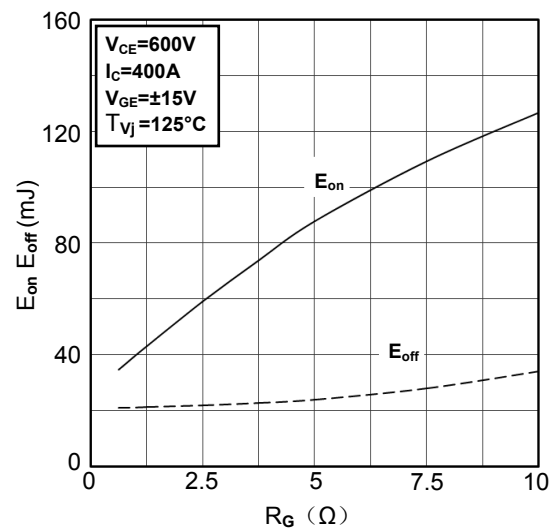

Figure4. Switching Energy vs. Gate Resistor

MMG400D120UK6HN

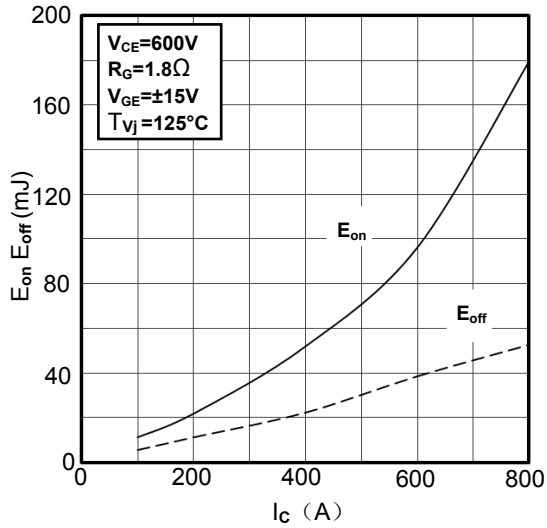

Figure 5. Switching Energy vs. Collector Current

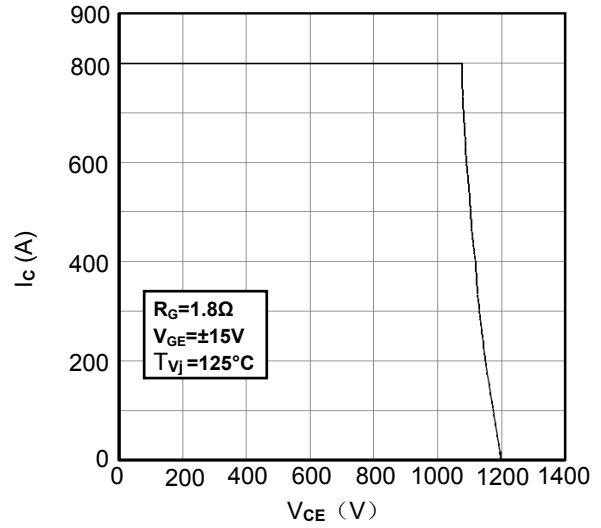

Figure 6. Reverse Biased Safe Operating Area

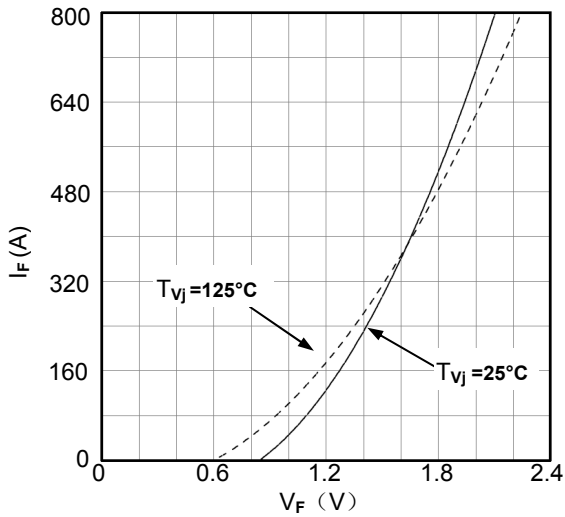

Figure 7. Diode Forward Characteristics

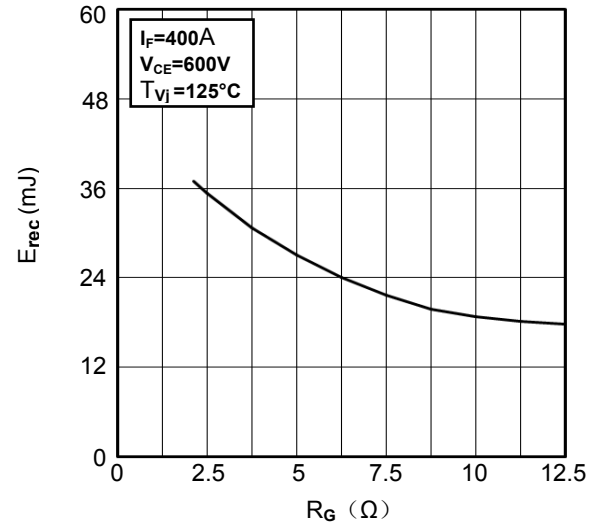

Figure 8. Switching Energy vs. Gate Resistor

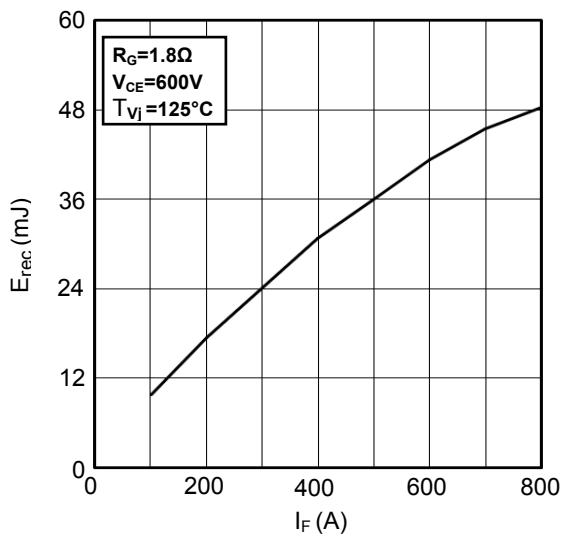

Figure 9. Switching Energy vs. Forward Current

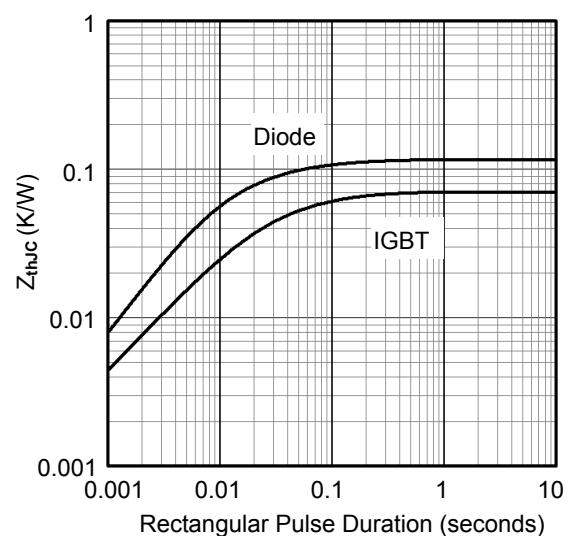

Figure 10. Transient Thermal Impedance

MMG400D120UK6HN

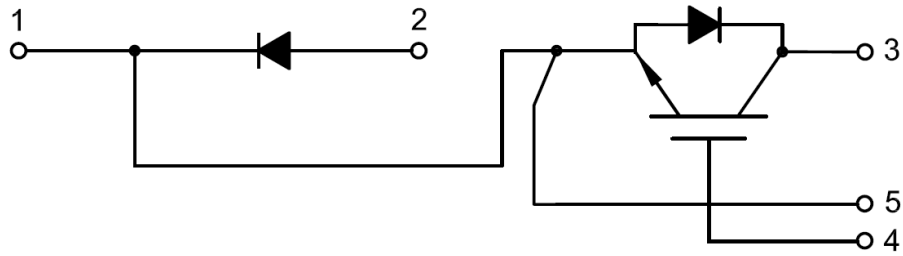
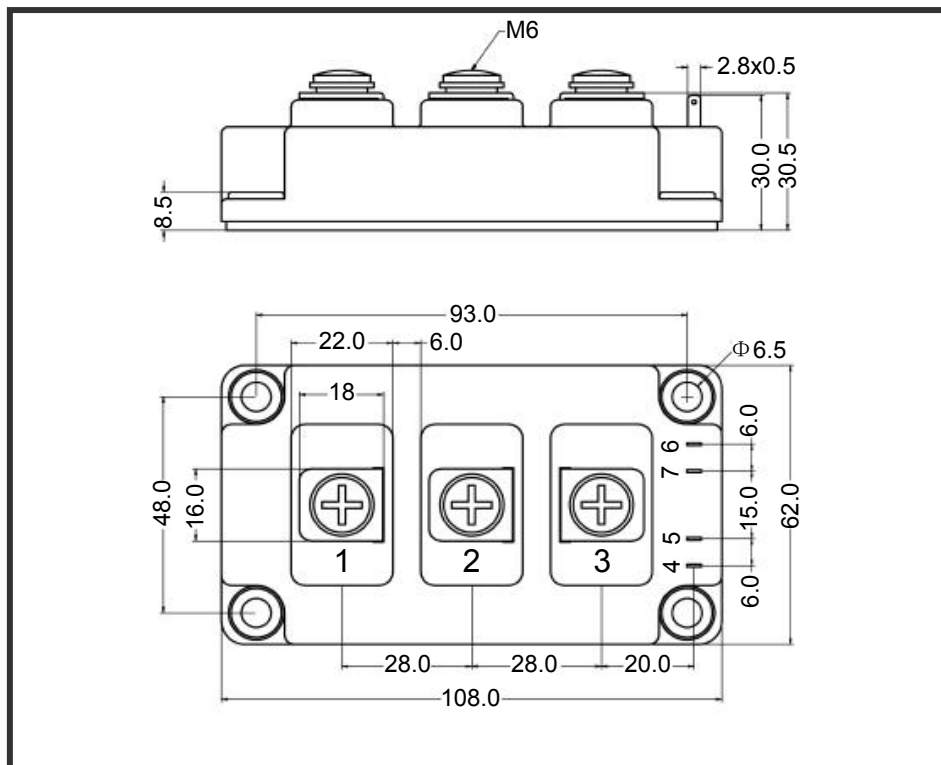

Figure11. Circuit Diagram



Dimensions (mm)
Figure12. Package Outline