

## PRODUCT FEATURES

- High short circuit capability, self limiting short circuit current
- $V_{CE(sat)}$  with positive temperature coefficient
- Fast switching and short tail current
- Free wheeling diodes with fast and soft reverse recovery
- Low switching losses



## APPLICATIONS

- High frequency switching application
- Medical applications
- Motion/servo control
- UPS systems

## IGBT-inverter

### ABSOLUTE MAXIMUM RATINGS

$T_C = 25^\circ\text{C}$  unless otherwise specified

Symbol	Parameter/Test Conditions		Values	Unit
$V_{CES}$	Collector Emitter Voltage	$T_J = 25^\circ\text{C}$	600	V
$V_{GES}$	Gate Emitter Voltage		$\pm 20$	
$I_C$	DC Collector Current	$T_C = 25^\circ\text{C}$	260	A
		$T_C = 65^\circ\text{C}$	200	
$I_{CM}$	Repetitive Peak Collector Current	$t_p = 1\text{ms}$	400	
$P_{tot}$	Power Dissipation Per IGBT		690	W

## Diode-inverter

### ABSOLUTE MAXIMUM RATINGS

$T_C = 25^\circ\text{C}$  unless otherwise specified

Symbol	Parameter/Test Conditions		Values	Unit
$V_{RRM}$	Repetitive Reverse Voltage	$T_J = 25^\circ\text{C}$	600	V
$I_{F(AV)}$	Average Forward Current	$T_C = 25^\circ\text{C}$	150	A
$I_{FRM}$	Repetitive Peak Forward Current	$t_p = 1\text{ms}$	300	
$i^2t$		$T_J = 125^\circ\text{C}$ , $t = 10\text{ms}$ , $V_R = 0\text{V}$	2550	$\text{A}^2\text{S}$

## IGBT-inverter ELECTRICAL CHARACTERISTICS

$T_C = 25^\circ\text{C}$  unless otherwise specified

Symbol	Parameter/Test Conditions		Min.	Typ.	Max.	Unit	
$V_{GE(th)}$	Gate Emitter Threshold Voltage	$V_{CE}=V_{GE}, I_C=3.2\text{mA}$	4.2	4.8	5.4	V	
$V_{CE(sat)}$	Collector Emitter Saturation Voltage	$I_C=200\text{A}, V_{GE}=15\text{V}, T_J=25^\circ\text{C}$		1.95	2.25		
		$I_C=200\text{A}, V_{GE}=15\text{V}, T_J=125^\circ\text{C}$		2.25			
$I_{CES}$	Collector Leakage Current	$V_{CE}=600\text{V}, V_{GE}=0\text{V}, T_J=25^\circ\text{C}$			1	mA	
		$V_{CE}=600\text{V}, V_{GE}=0\text{V}, T_J=125^\circ\text{C}$			5	mA	
$I_{GES}$	Gate Leakage Current	$V_{CE}=0\text{V}, V_{GE}=\pm 15\text{V}, T_J=125^\circ\text{C}$	-400		400	nA	
$R_{gint}$	Integrated Gate Resistor			1.1		$\Omega$	
$Q_g$	Gate Charge	$V_{CE}=300\text{V}, I_C=200\text{A}, V_{GE}=15\text{V}$		1		$\mu\text{C}$	
$C_{ies}$	Input Capacitance	$V_{CE}=25\text{V}, V_{GE}=0\text{V}, f=1\text{MHz}$		12.5		nF	
$C_{res}$	Reverse Transfer Capacitance				0.36		nF
$t_{d(on)}$	Turn on Delay Time	$V_{CC}=300\text{V}, I_C=200\text{A}$ $R_G=10\Omega,$ $V_{GE}=\pm 15\text{V},$ Inductive Load	$T_J=25^\circ\text{C}$		70		ns
			$T_J=125^\circ\text{C}$		80		ns
$t_r$	Rise Time		$T_J=25^\circ\text{C}$		80		ns
			$T_J=125^\circ\text{C}$		100		ns
$t_{d(off)}$	Turn off Delay Time	$V_{CC}=300\text{V}, I_C=200\text{A}$ $R_G=10\Omega,$ $V_{GE}=\pm 15\text{V},$ Inductive Load	$T_J=25^\circ\text{C}$		420		ns
			$T_J=125^\circ\text{C}$		450		ns
$t_f$	Fall Time		$T_J=25^\circ\text{C}$		50		ns
			$T_J=125^\circ\text{C}$		60		ns
$E_{on}$	Turn on Energy	$V_{CC}=300\text{V}, I_C=200\text{A}$ $R_G=10\Omega,$ $V_{GE}=\pm 15\text{V},$ Inductive Load	$T_J=25^\circ\text{C}$		1.6		mJ
			$T_J=125^\circ\text{C}$		2.1		mJ
$E_{off}$	Turn off Energy		$T_J=25^\circ\text{C}$		6.5		mJ
			$T_J=125^\circ\text{C}$		7.5		mJ
$I_{sc}$	Short Circuit Current	$tp_{sc} \leq 10\mu\text{s}, V_{GE}=15\text{V}$ $T_J=125^\circ\text{C}, V_{CC}=360\text{V}$		900		A	
$R_{thJC}$	Junction to Case Thermal Resistance ( Per IGBT )				0.18	K /W	

## Diode-inverter ELECTRICAL CHARACTERISTICS

$T_C = 25^\circ\text{C}$  unless otherwise specified

Symbol	Parameter/Test Conditions		Min.	Typ.	Max.	Unit
$V_F$	Forward Voltage	$I_F=150\text{A}, V_{GE}=0\text{V}, T_J=25^\circ\text{C}$		1.55	1.95	V
		$I_F=150\text{A}, V_{GE}=0\text{V}, T_J=125^\circ\text{C}$		1.50		
$t_{rr}$	Reverse Recovery Time	$I_F=150\text{A}, V_R=300\text{V}$		175		ns
$I_{RRM}$	Max. Reverse Recovery Current	$di_F/dt=-2000\text{A}/\mu\text{s}$		100		A
$Q_{RR}$	Reverse Recovery Charge	$T_J=125^\circ\text{C}$		11		$\mu\text{C}$
$E_{rec}$	Reverse Recovery Energy				2.6	
$R_{thJCD}$	Junction to Case Thermal Resistance ( Per Diode )				0.5	K /W

**MODULE CHARACTERISTICS**

$T_C = 25^\circ\text{C}$  unless otherwise specified

Symbol	Parameter/Test Conditions		Values	Unit
$T_{Jmax}$	Max. Junction Temperature		150	°C
$T_{Jop}$	Operating Temperature		-40~125	
$T_{stg}$	Storage Temperature		-40~125	
$V_{isol}$	Isolation Breakdown Voltage	AC, 50Hz(R.M.S), t=1minute	3000	V
CTI	Comparative Tracking Index		> 200	
Torque	to heatsink	Recommended (M6)	3~5	Nm
	to terminal	Recommended (M5)	2.5~5	Nm
Weight			160	g

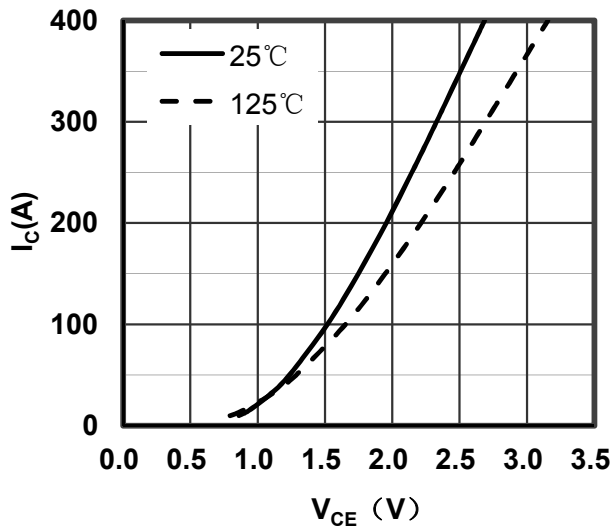

Figure 1. Typical Output Characteristics IGBT-inverter

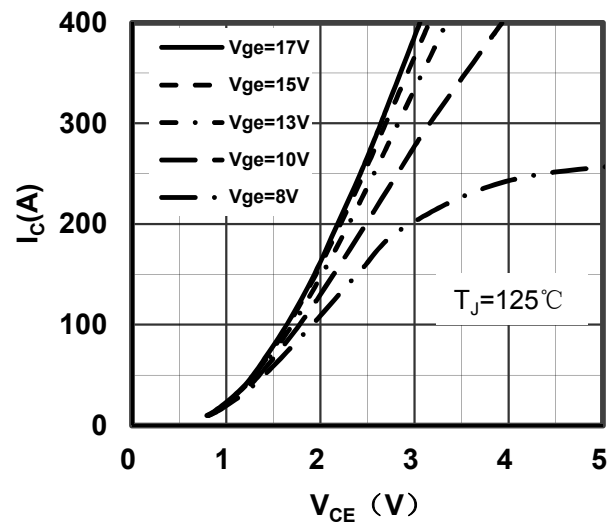

Figure 2. Typical Output Characteristics IGBT-inverter

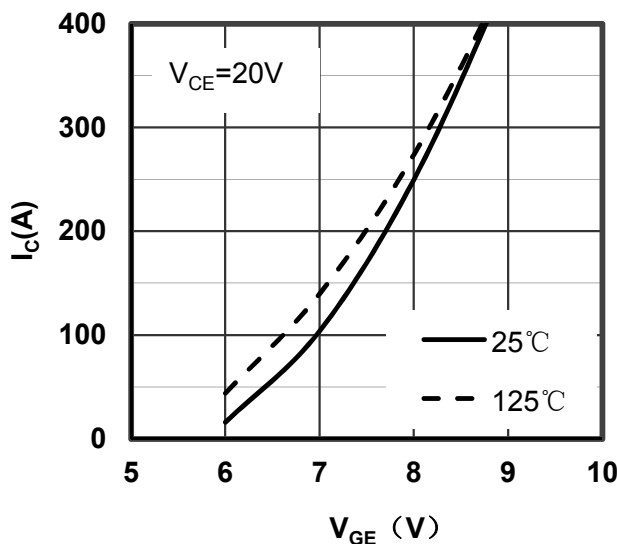

Figure 3. Typical Transfer Characteristics IGBT-inverter

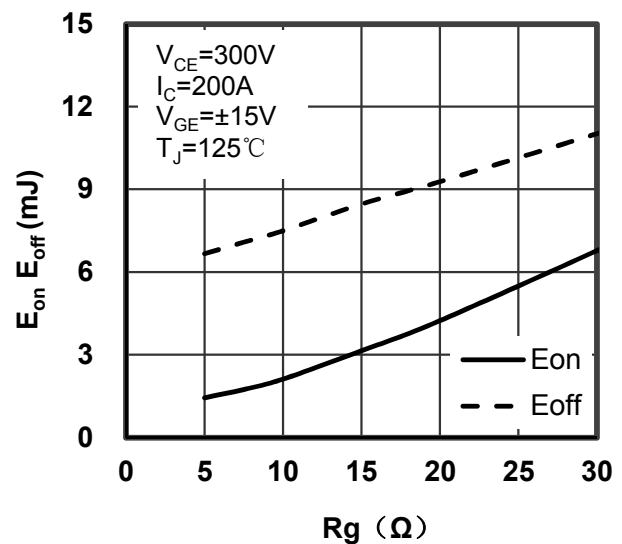

Figure 4. Switching Energy vs Gate Resistor IGBT-inverter

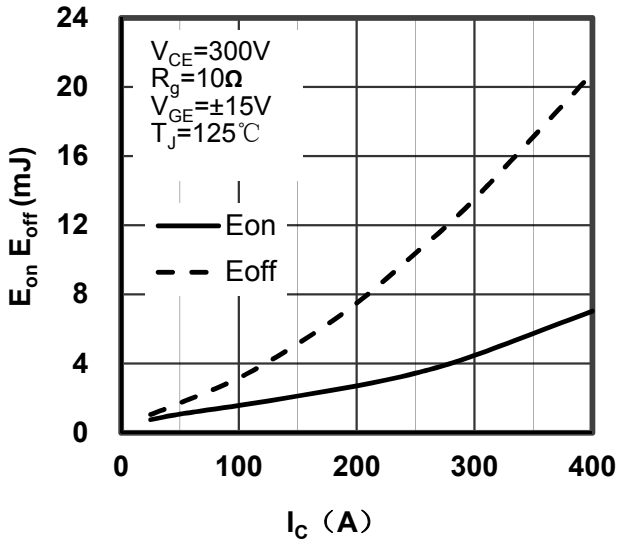

Figure 5. Switching Energy vs Collector Current IGBT-inverter

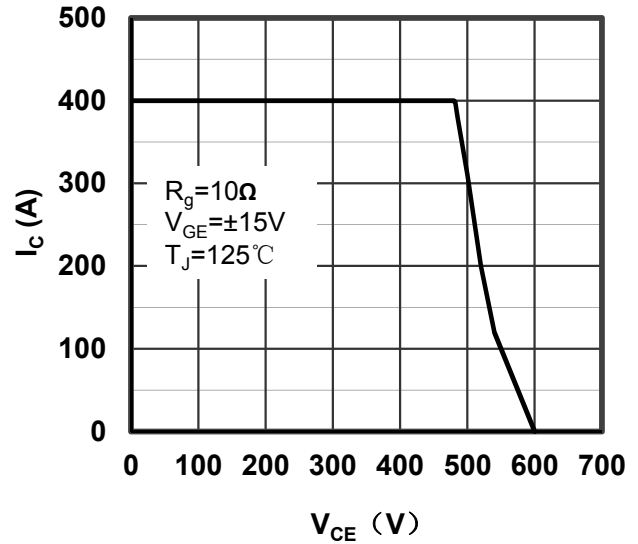

Figure 6. Reverse Biased Safe Operating Area IGBT-inverter

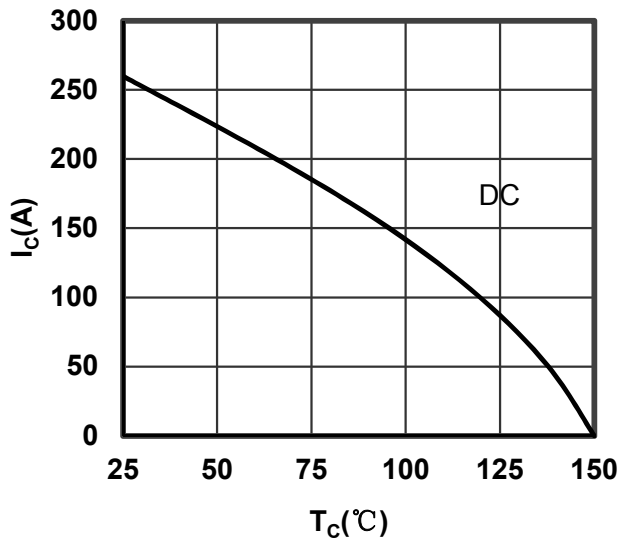

Figure 7. Collector Current vs Case temperature IGBT-inverter

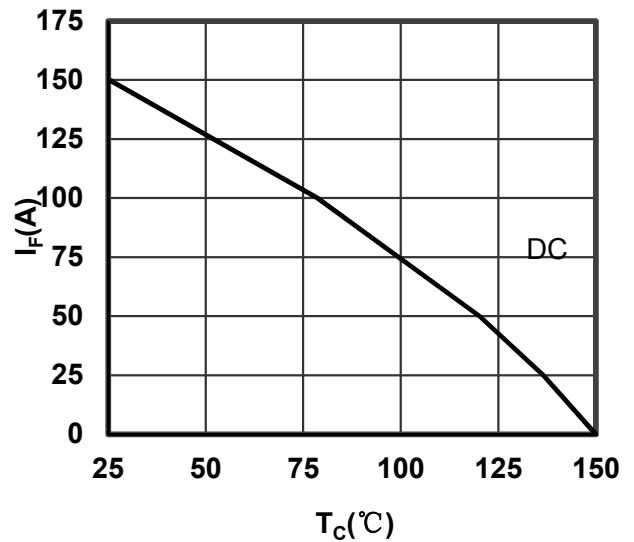

Figure 8. Forward current vs Case temperature Diode-inverter

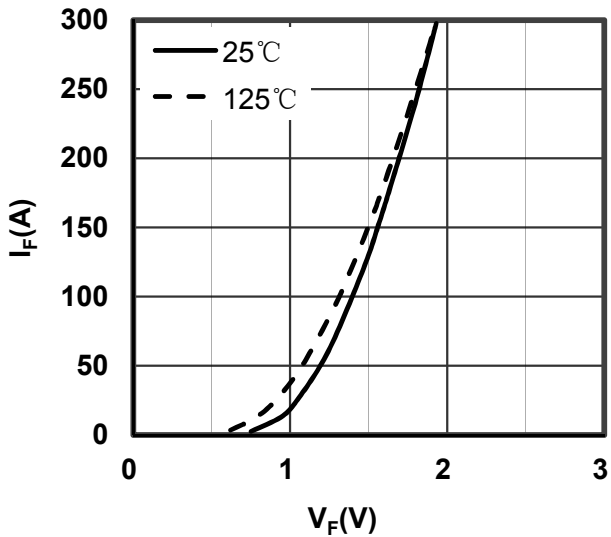

Figure 9. Diode Forward Characteristics Diode-inverter

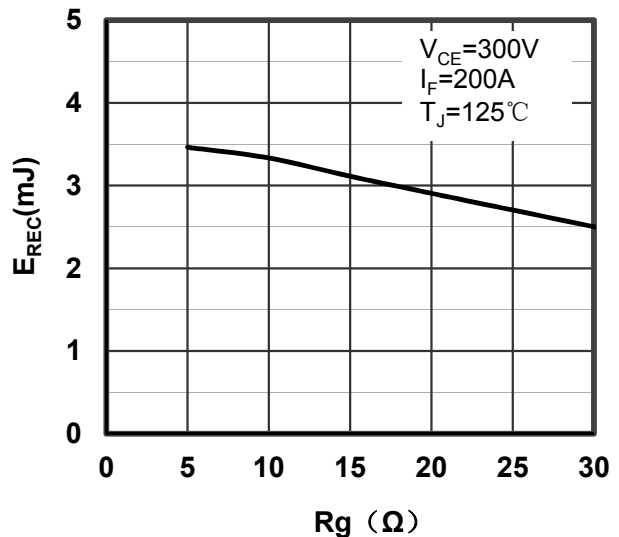

Figure 10. Switching Energy vs Gate Resistor Diode-inverter

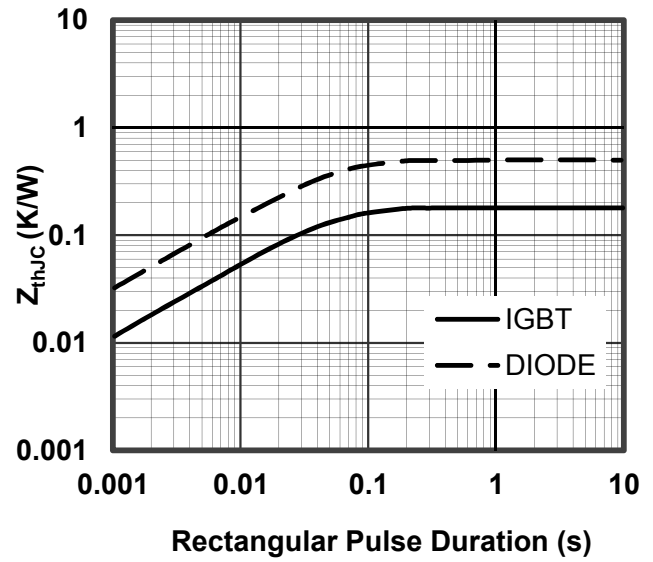
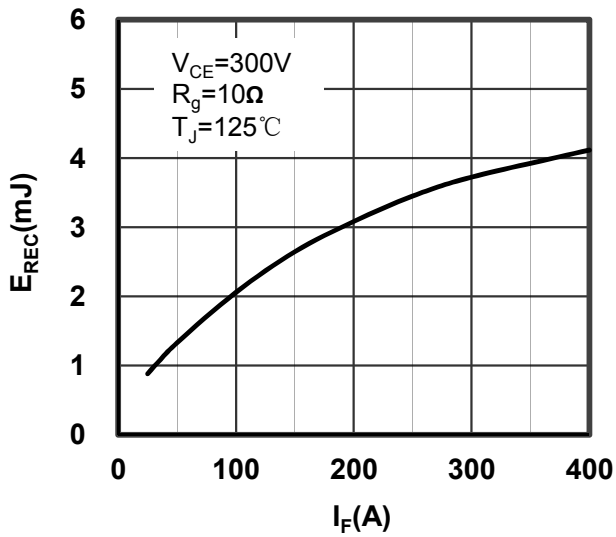

Figure 11. Switching Energy vs Forward Current Diode-inverter

Figure 12. Transient Thermal Impedance of Diode and IGBT-inverter

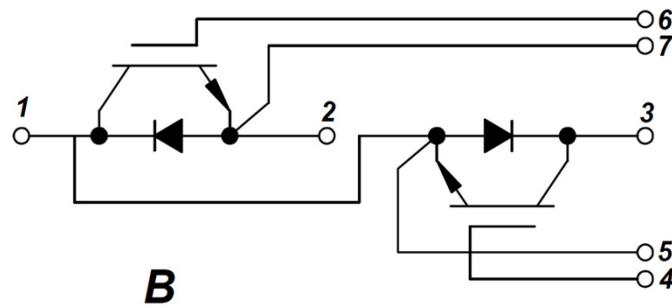
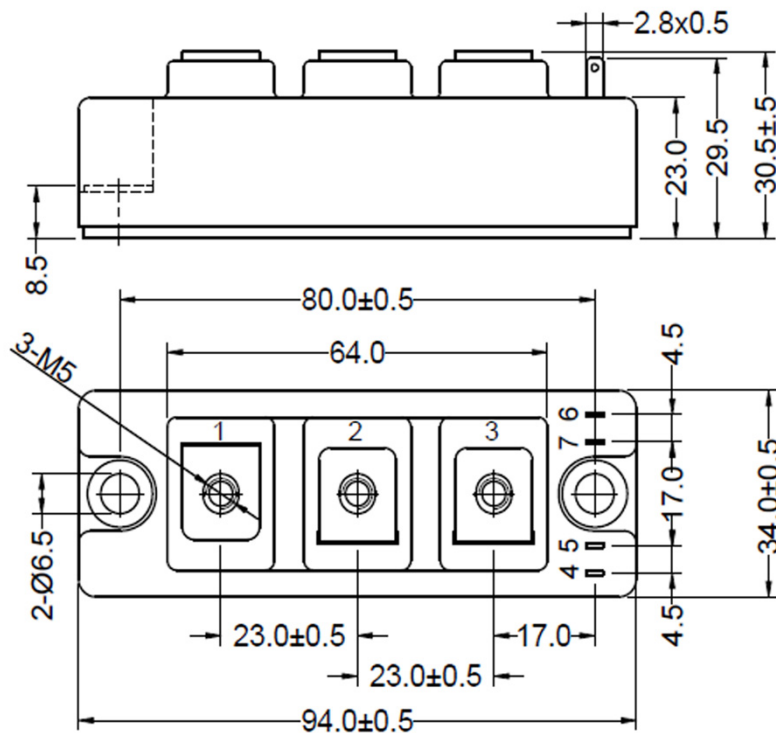

Figure 13. Circuit Diagram



Dimensions in (mm)  
Figure 14. Package Outline