

PRODUCT FEATURES

- IGBT³ CHIP(Trench+Field Stop technology)
- High short circuit capability,self limiting short circuit current
- $V_{CE(sat)}$ with positive temperature coefficient
- Fast switching and short tail current
- Free wheeling diodes with fast and soft reverse recovery
- Low switching losses

APPLICATIONS

- High frequency switching application
- Medical applications
- Motion/servo control
- UPS systems



IGBT-inverter

ABSOLUTE MAXIMUM RATINGS ($T_C=25^\circ\text{C}$ unless otherwise specified)

Symbol	Parameter/Test Conditions	Values	Uni	
V_{CES}	Collector Emitter Voltage $T_J=25^\circ\text{C}$	650	V	
V_{GES}	Gate Emitter Voltage	± 20		
I_C	DC Collector Current	$T_C=25^\circ\text{C}$	200	A
		$T_C=80^\circ\text{C}$	150	
I_{CM}	Repetitive Peak Collector Current $t_p=1\text{ms}$	300		
P_{tot}	Power Dissipation Per IGBT	428	W	

Diode-inverter

ABSOLUTE MAXIMUM RATINGS ($T_C=25^\circ\text{C}$ unless otherwise specified)

Symbol	Parameter/Test Conditions	Values	Uni
V_{RRM}	Repetitive Reverse Voltage $T_J=25^\circ\text{C}$	650	V
$I_{F(AV)}$	Average Forward Current $T_C=25^\circ\text{C}$	150	A
I_{FRM}	Repetitive Peak Forward Current $t_p=1\text{ms}$	300	
I^2t		$T_J=125^\circ\text{C}$, $t=10\text{ms}$, $V_R=0\text{V}$	A ² S

IGBT-inverter

ELECTRICAL CHARACTERISTICS ($T_C=25^\circ\text{C}$ unless otherwise specified)

Symbol	Parameter/Test Conditions		Min.	Typ.	Max.	Uni	
$V_{GE(th)}$	Gate Emitter Threshold Voltage	$V_{CE}=V_{GE}, I_C=2.4\text{mA}$	4.9	5.8	6.5	V	
$V_{CE(sat)}$	Collector Emitter Saturation Voltage	$I_C=150\text{A}, V_{GE}=15\text{V}, T_J=25^\circ\text{C}$		1.45	1.9		
		$I_C=150\text{A}, V_{GE}=15\text{V}, T_J=150^\circ\text{C}$		1.7			
I_{CES}	Collector Leakage Current	$V_{CE}=650\text{V}, V_{GE}=0\text{V}, T_J=25^\circ\text{C}$			1	mA	
		$V_{CE}=650\text{V}, V_{GE}=0\text{V}, T_J=150^\circ\text{C}$			5	mA	
I_{GES}	Gate Leakage Current	$V_{CE}=0\text{V}, V_{GE}=\pm 15\text{V}, T_J=150^\circ\text{C}$	-400		400	nA	
R_{gint}	Integrated Gate Resistor			2		Ω	
Q_g	Gate Charge	$V_{CE}=300\text{V}, I_C=150\text{A}, V_{GE}=\pm$		0.95		μC	
C_{ies}	Input Capacitance	$V_{CE}=25\text{V}, V_{GE}=0\text{V}, f=1\text{MHz}$		9.3		nF	
C_{res}	Reverse Transfer Capacitance				290		pF
$t_{d(on)}$	Turn on Delay Time	$V_{CC}=300\text{V}, I_C=150\text{A}, R_G=2.2\Omega, V_{GE}=\pm 15\text{V},$ Inductive Load	$T_J=25^\circ\text{C}$		200		ns
			$T_J=150^\circ\text{C}$		210		ns
t_r	Rise Time		$T_J=25^\circ\text{C}$		70		ns
			$T_J=150^\circ\text{C}$		80		ns
$t_{d(off)}$	Turn off Delay Time	$V_{CC}=300\text{V}, I_C=150\text{A}, R_G=2.2\Omega, V_{GE}=\pm 15\text{V},$ Inductive Load	$T_J=25^\circ\text{C}$		300		ns
			$T_J=150^\circ\text{C}$		330		ns
t_f	Fall Time		$T_J=25^\circ\text{C}$		50		ns
			$T_J=150^\circ\text{C}$		70		ns
E_{on}	Turn on Energy	$V_{CC}=300\text{V}, I_C=150\text{A}, R_G=2.2\Omega, V_{GE}=\pm 15\text{V},$ Inductive Load	$T_J=25^\circ\text{C}$		0.75		mJ
			$T_J=150^\circ\text{C}$		1.2		mJ
E_{off}	Turn off Energy		$T_J=25^\circ\text{C}$		4		mJ
			$T_J=150^\circ\text{C}$		5.15		mJ
I_{SC}	Short Circuit Current	$t_{psc}\leq 6\mu\text{s}, V_{GE}=15\text{V}, T_J=125^\circ\text{C}, V_{CC}=360\text{V}$		750		A	
R_{thJC}	Junction to Case Thermal Resistance (Per IGBT)				0.35	K/W	

Diode-inverter

ELECTRICAL CHARACTERISTICS ($T_C=25^\circ\text{C}$ unless otherwise specified)

Symbol	Parameter/Test Conditions		Min.	Typ.	Max.	Uni
V_F	Forward Voltage	$I_F=150\text{A}, V_{GE}=0\text{V}, T_J=25^\circ\text{C}$		1.55	1.95	V
		$I_F=150\text{A}, V_{GE}=0\text{V}, T_J=150^\circ\text{C}$		1.45		
t_{rr}	Reverse Recovery Time	$I_F=150\text{A}, V_R=300\text{V}$		210		ns
I_{RRM}	Max. Reverse Recovery Current	$di_F/dt=-1600\text{A}/\mu\text{s}$		95		A
Q_{RR}	Reverse Recovery Charge	$T_J=150^\circ\text{C}$		11		μC
E_{rec}	Reverse Recovery Energy			3.5		mJ
R_{thJCD}	Junction to Case Thermal Resistance (Per Diode)				0.6	K/W

NTC CHARACTERISTICS ($T_C=25^\circ\text{C}$ unless otherwise specified)

Symbol	Parameter/Test Conditions		Min.	Typ.	Max.	Uni
R_{25}	Resistance	$T_C=25^\circ\text{C}$		5		K Ω
$B_{25/50}$	$R_2 = R_{25} \exp [B_{25/50}(1/T_2 - 1/(298,15 \text{ K}))]$			3375		K

MODULE CHARACTERISTICS ($T_C=25^\circ\text{C}$ unless otherwise specified)

Symbol	Parameter/Test Conditions		Values	Uni
T_{Jmax}	Max. Junction Temperature		175	°C
T_{Jop}	Operating Temperature		-40~150	
T_{stg}	Storage Temperature		-40~125	
V_{isol}	Isolation Breakdown Voltage	AC, 50Hz(R.M.S), t=1minute	3000	V
CTI	Comparative Tracking Index		> 200	
Torque	to heatsink	Recommended (M6)	3~5	Nm
	to terminal	Recommended (M6)	3~5	Nm
Weight			300	g

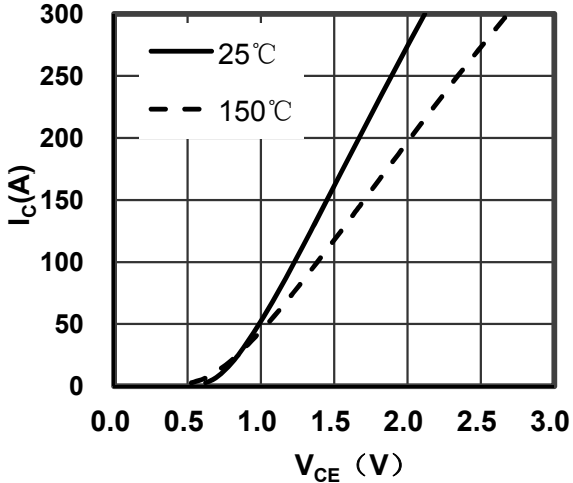

Figure 1. Typical Output Characteristics IGBT-inverter

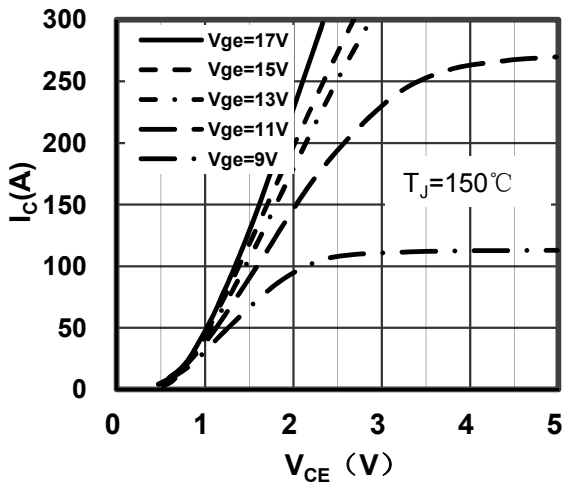

Figure 2. Typical Output Characteristics IGBT-inverter

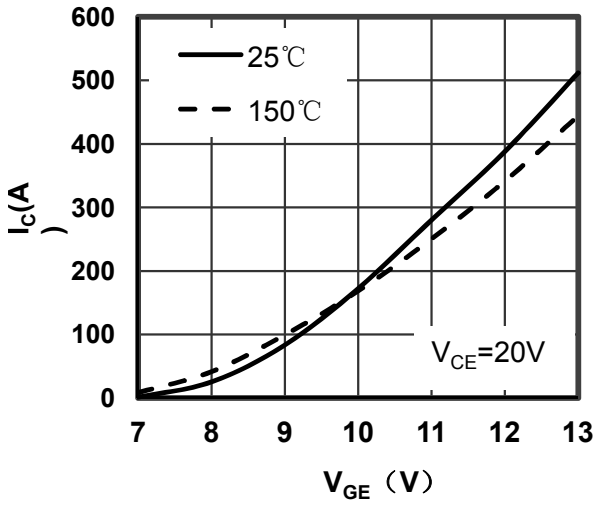

Figure 3. Typical Transfer characteristics IGBT-inverter

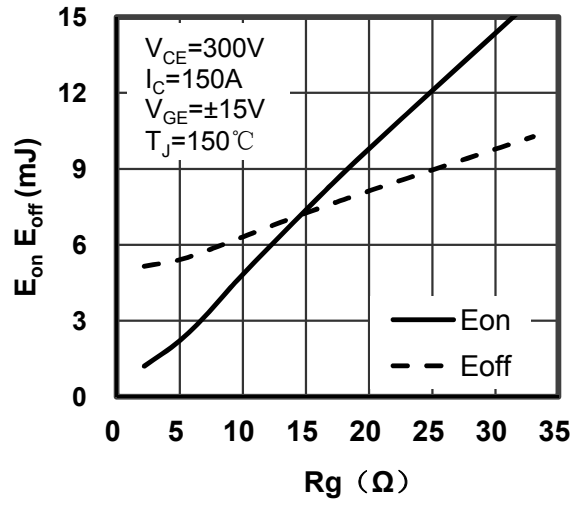

Figure 4. Switching Energy vs Gate Resistor IGBT-inverter

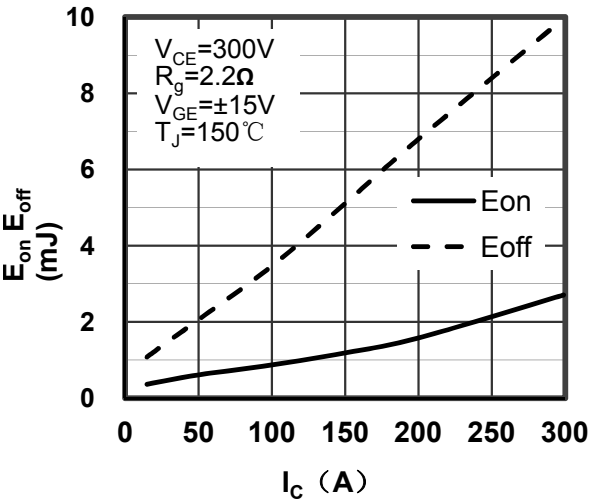

Figure 5. Switching Energy vs Collector Current IGBT-inverter

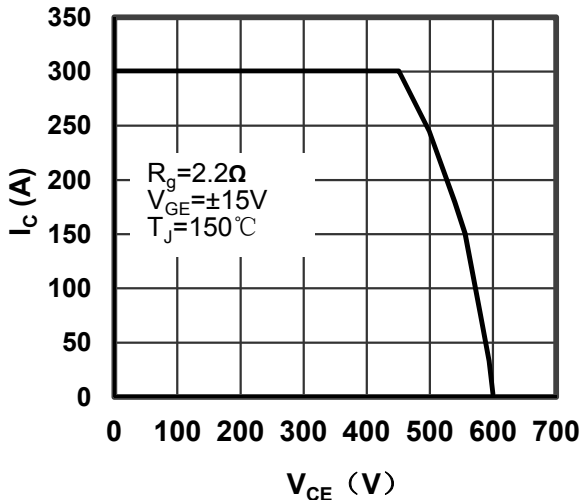

Figure 6. Reverse Biased Safe Operating Area

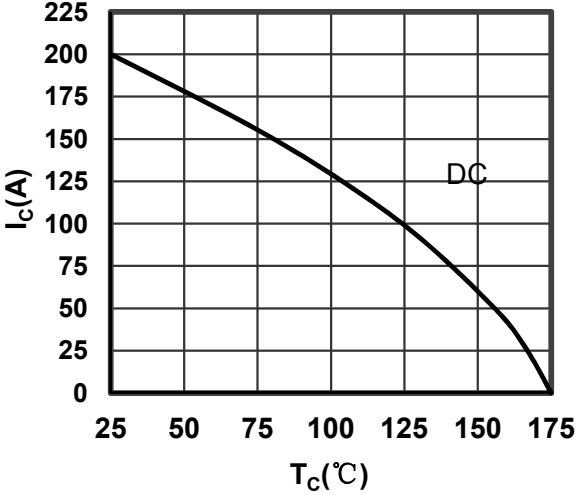

Figure 7. Collector Current vs Case temperature IGBT -inverter

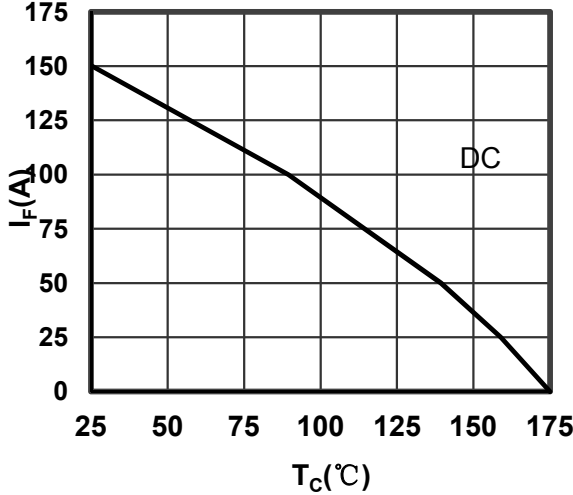

Figure 8. Forward current vs Case temperature

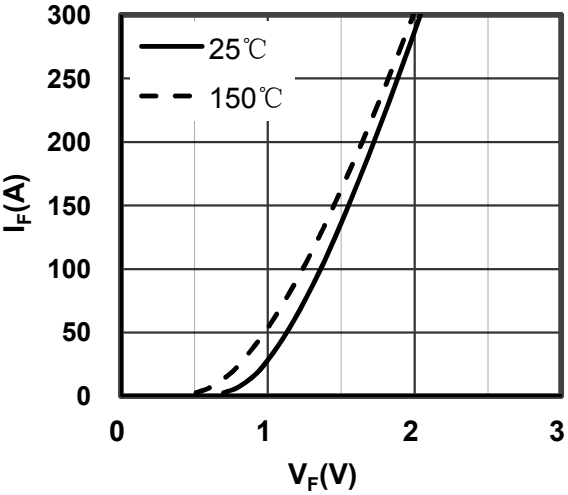

Figure 9. Diode Forward Characteristics Diode -inverter

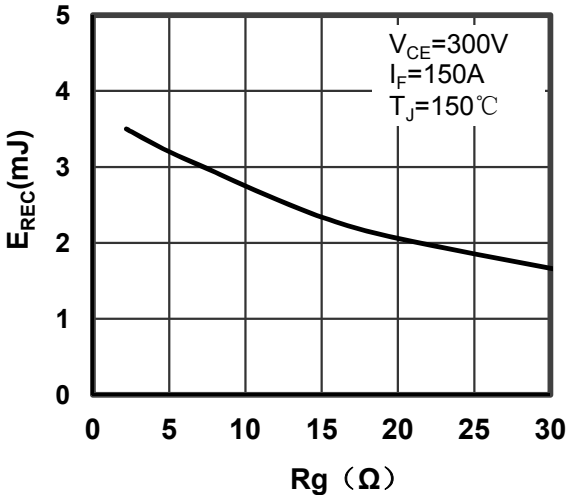

Figure 10. Switching Energy vs Gate Resistor Diode -inverter

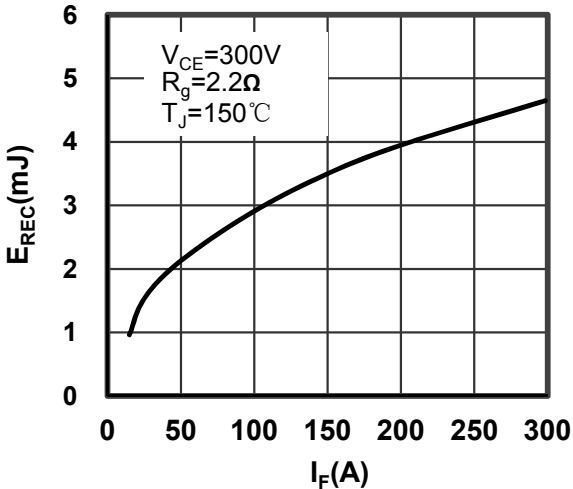

Figure 11. Switching Energy vs Forward Current Diode-inverter

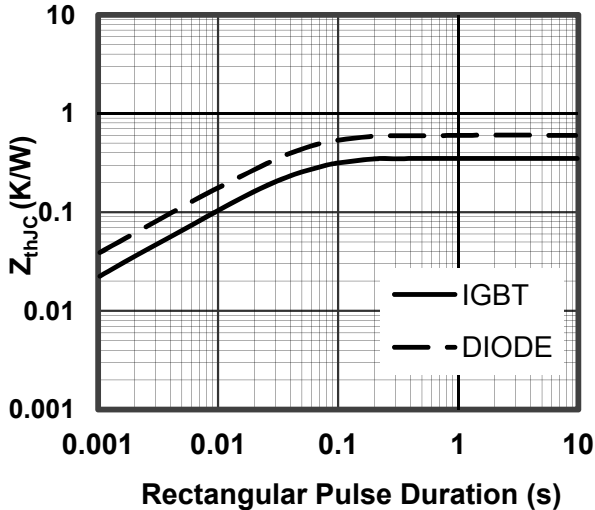

Figure 12. Transient Thermal Impedance of Diode and IGBT-inverter

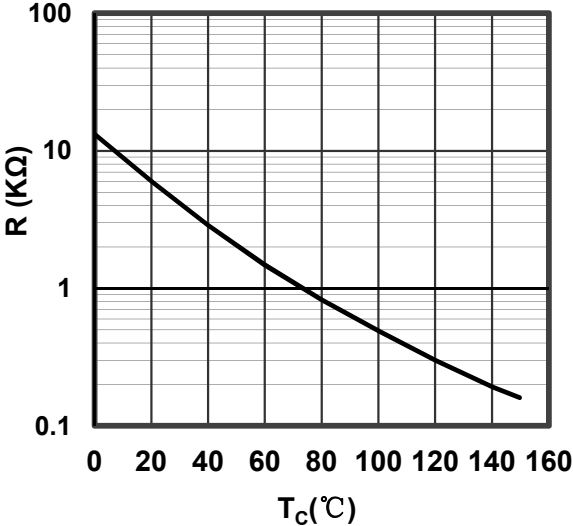

Figure 13. NTC Characteristics

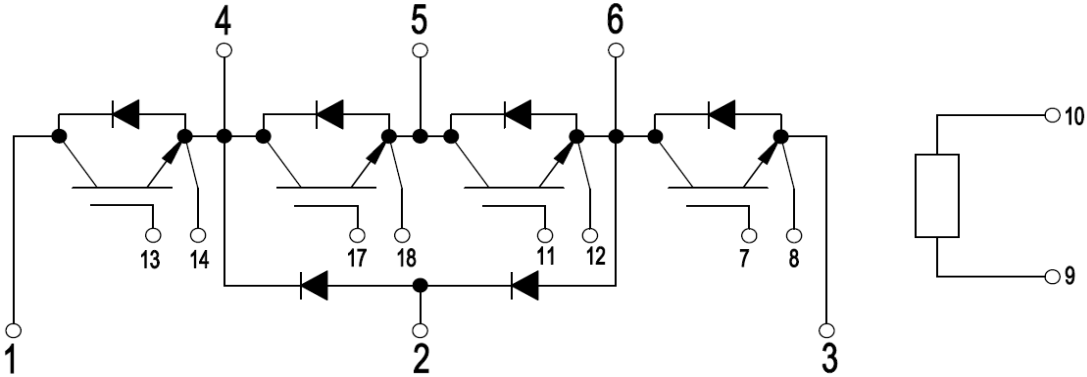
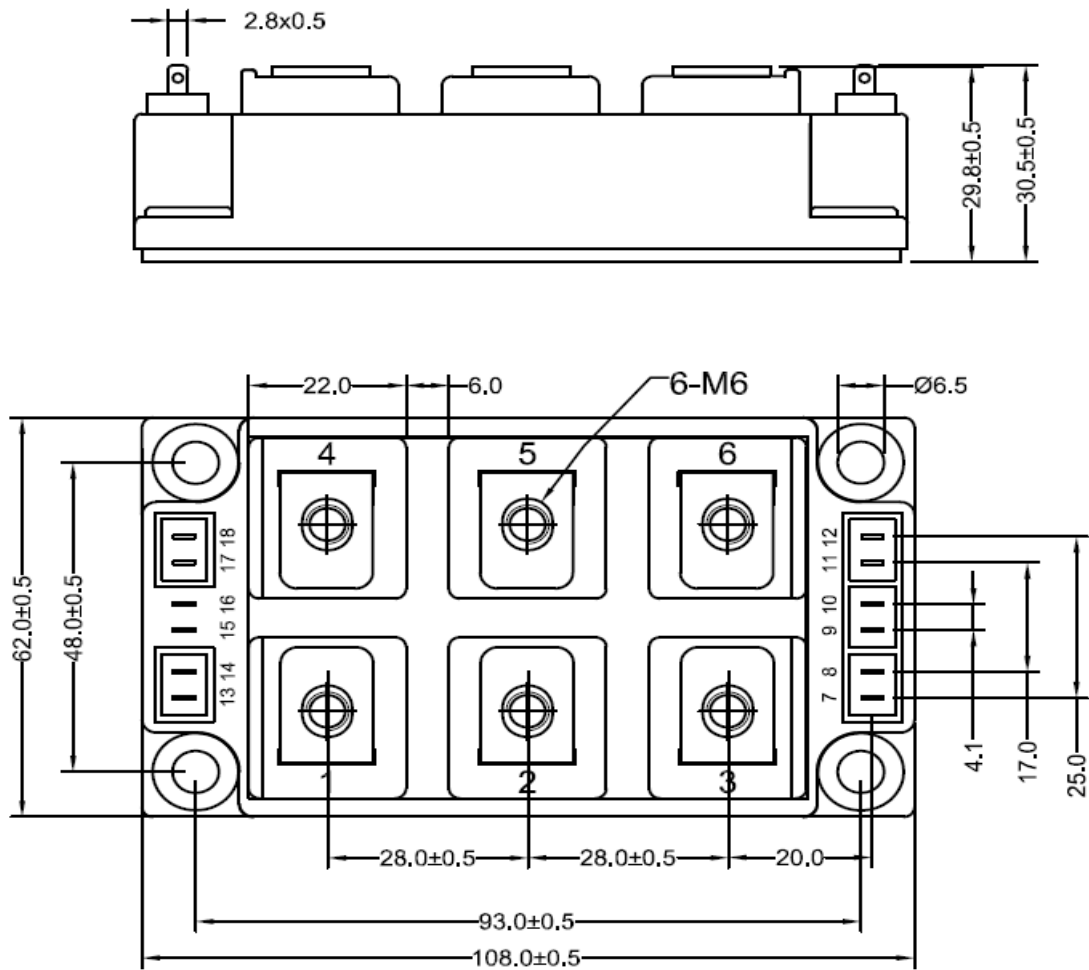

Figure 14. Circuit Diagram



Dimensions in (mm)
 Figure 15. Package Outline