



PRODUCT FEATURES

- Ultrafast Reverse Recovery Time
- Soft Reverse Recovery Characteristics
- Low Reverse Recovery Loss
- Low Forward Voltage
- High Surge Current Capability
- Low Inductance Package



APPLICATIONS

- Inversion Welder
- Uninterruptible Power Supply (UPS)
- Plating Power Supply
- Ultrasonic Cleaner and Welder
- Converter & Chopper
- Power Factor Correction (PFC) Circuit

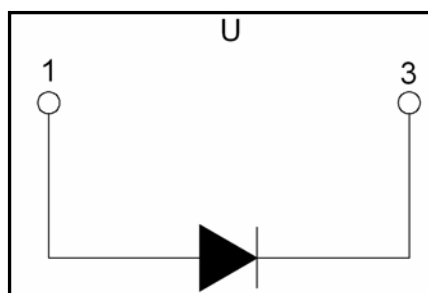

ABSOLUTE MAXIMUM RATINGS

$T_C=25^{\circ}\text{C}$ unless otherwise specified

Symbol	Parameter	Test Conditions	Values	Unit
V_R	Maximum D.C. Reverse Voltage		1200	V
V_{RRM}	Maximum Repetitive Reverse Voltage		1200	V
$I_{F(AV)}$	Average Forward Current	$T_C=100^{\circ}\text{C}$	300	A
		$T_C=110^{\circ}\text{C}, 20\text{KHz}$	210	A
$I_{F(RMS)}$	RMS Forward Current	$T_C=100^{\circ}\text{C}$	420	A
I_{FSM}	Non-Repetitive Surge Forward Current	$T_J=45^{\circ}\text{C}, t=10\text{ms}, 50\text{Hz}, \text{Sine}$	2500	A
		$T_J=45^{\circ}\text{C}, t=8.3\text{ms}, 60\text{Hz}, \text{Sine}$	2800	A
I^2t	I^2t (For Fusing)	$T_J=45^{\circ}\text{C}, t=10\text{ms}, 50\text{Hz}, \text{Sine}$	31250	A^2s
		$T_J=45^{\circ}\text{C}, t=8.3\text{ms}, 60\text{Hz}, \text{Sine}$	32500	A^2s
P_D	Power Dissipation		890	W
T_J	Junction Temperature		-40 to +150	$^{\circ}\text{C}$
T_{STG}	Storage Temperature Range		-40 to +125	$^{\circ}\text{C}$
V_{isol}	Insulation Test Voltage	AC, $t=1\text{min}$	3000	V
Torque	Module-to-Sink	Recommended (M6)	3~5	N·m
Torque	Module Electrodes	Recommended (M6)	3~5	N·m
$R_{\theta JC}$	Thermal Resistance	Junction-to-Case	0.14	$^{\circ}\text{C}/\text{W}$
Weight			160	g



ELECTRICAL CHARACTERISTICS

$T_C=25^{\circ}\text{C}$ unless otherwise specified

Symbol	Parameter	Test Conditions	Min.	Typ.	Max.	Unit
I_{RM}	Reverse Leakage Current	$V_R=1200\text{V}$	--	--	5	mA
		$V_R=1200\text{V}, T_J=125^{\circ}\text{C}$	--	--	20	mA
V_F	Forward Voltage	$I_F=300\text{A}$	--	2.75	--	V
		$I_F=300\text{A}, T_J=125^{\circ}\text{C}$	--	1.85	--	V
t_{rr}	Reverse Recovery Time	$I_F=1\text{A}, V_R=30\text{V}, di_F/dt=-200\text{A}/\mu\text{s}$	--	75	--	ns
t_{rr}	Reverse Recovery Time	$V_R=600\text{V}, I_F=300\text{A}$ $di_F/dt=-200\text{A}/\mu\text{s}, T_J=25^{\circ}\text{C}$	--	150	--	ns
I_{RRM}	Max. Reverse Recovery Current		--	12	--	A
t_{rr}	Reverse Recovery Time	$V_R=600\text{V}, I_F=300\text{A}$ $di_F/dt=-200\text{A}/\mu\text{s}, T_J=125^{\circ}\text{C}$	--	450	--	ns
I_{RRM}	Max. Reverse Recovery Current		--	27	--	A

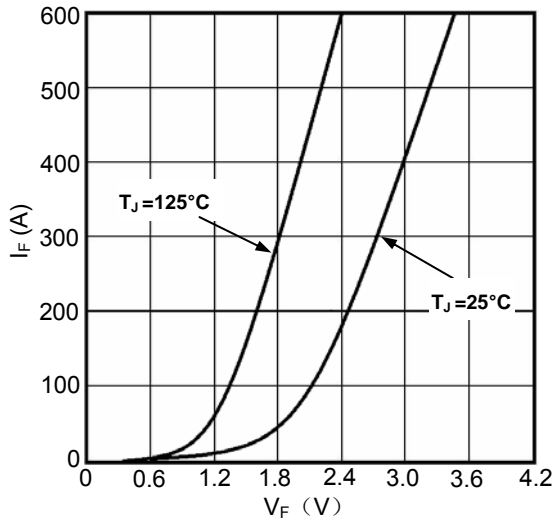

Figure1. Forward Voltage Drop vs Forward Current

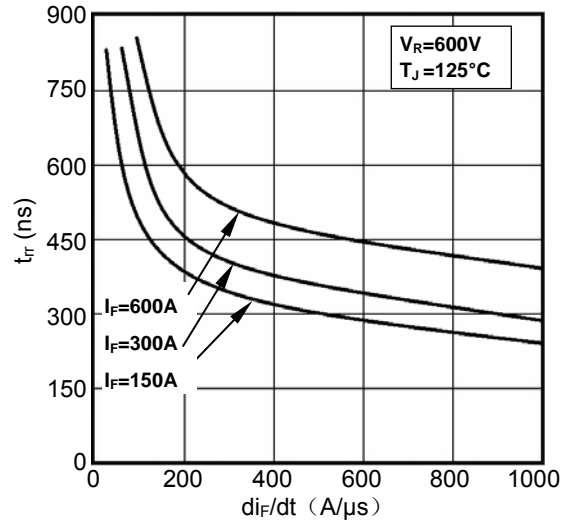

Figure2. Reverse Recovery Time vs di_F/dt

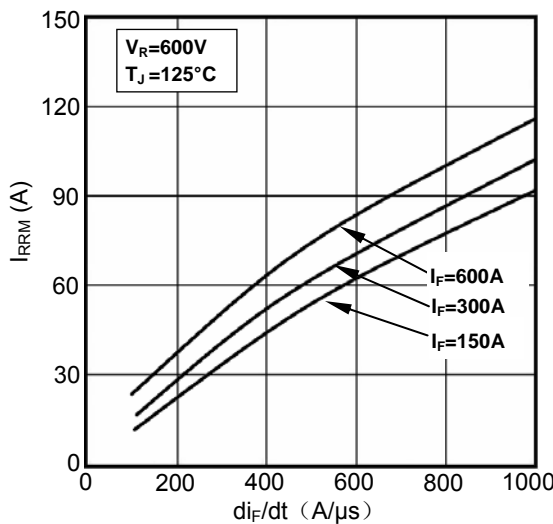

Figure3. Reverse Recovery Current vs di_F/dt

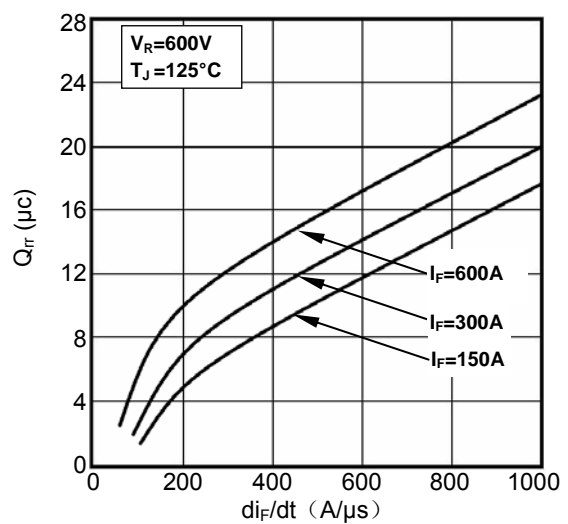

Figure4. Reverse Recovery Charge vs di_F/dt

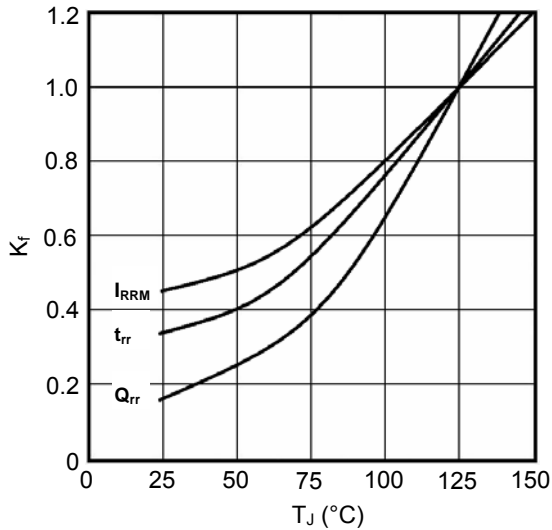

Figure5. Dynamic Parameters vs Junction Temperature

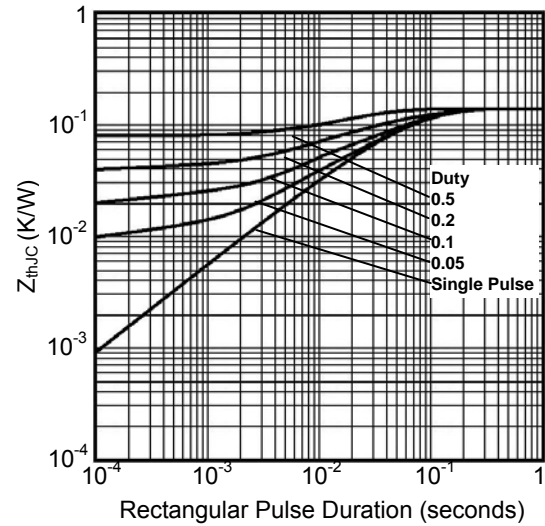
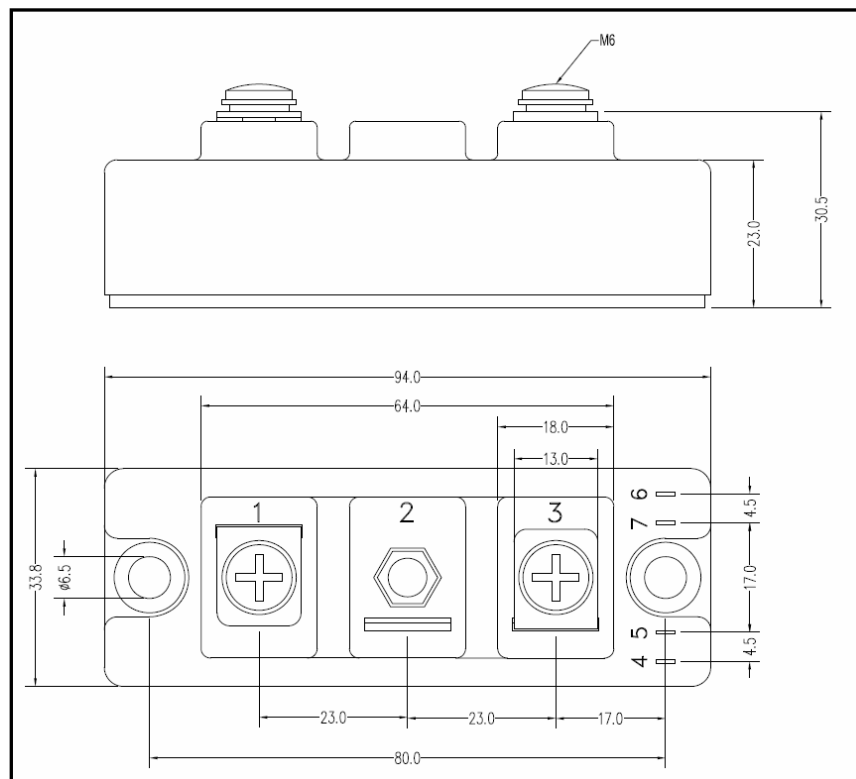

Figure6. Transient Thermal Impedance



Dimensions (mm)
Figure7. Package Outline