

PRODUCT FEATURES

- Ultrafast Reverse Recovery Time
- Soft Reverse Recovery Characteristics
- Low Reverse Recovery Loss
- Low Forward Voltage
- High Surge Current Capability
- Low Inductance Package



APPLICATIONS

- Inversion Welder
- Uninterruptible Power Supply (UPS)
- Plating Power Supply
- Ultrasonic Cleaner and Welder
- Converter & Chopper
- Power Factor Correction (PFC) Circuit

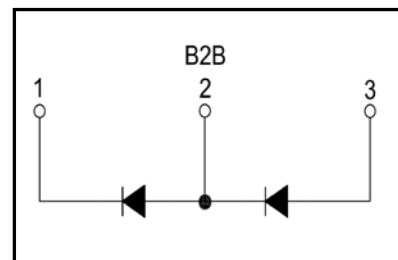

ABSOLUTE MAXIMUM RATINGS

$T_C=25^{\circ}\text{C}$ unless otherwise specified

| Symbol | Parameter | Test Conditions | Values | Unit |
|-----------------|--------------------------------------|--|-------------|-----------------------------|
| V_R | Maximum D.C. Reverse Voltage | | 1200 | V |
| V_{RRM} | Maximum Repetitive Reverse Voltage | | 1200 | V |
| $I_{F(AV)}$ | Average Forward Current | $T_C=110^{\circ}\text{C}$, Per Diode | 300 | A |
| | | $T_C=120^{\circ}\text{C}$, 20KHz, Per Diode | 200 | A |
| $I_{F(RMS)}$ | RMS Forward Current | $T_C=110^{\circ}\text{C}$, Per Diode | 420 | A |
| I_{FSM} | Non-Repetitive Surge Forward Current | $T_J=45^{\circ}\text{C}$, $t=10\text{ms}$, 50Hz, Sine | 2700 | A |
| | | $T_J=45^{\circ}\text{C}$, $t=8.3\text{ms}$, 60Hz, Sine | 2850 | A |
| I^2t | I^2t (For Fusing) | $T_J=45^{\circ}\text{C}$, $t=10\text{ms}$, 50Hz, Sine | 36450 | A^2s |
| | | $T_J=45^{\circ}\text{C}$, $t=8.3\text{ms}$, 60Hz, Sine | 40612 | A^2s |
| P_D | Power Dissipation | | 893 | W |
| T_J | Junction Temperature | | -40 to +150 | $^{\circ}\text{C}$ |
| T_{STG} | Storage Temperature Range | | -40 to +125 | $^{\circ}\text{C}$ |
| V_{isol} | Insulation Test Voltage | AC, $t=1\text{min}$ | 3000 | V |
| Torque | Module-to-Sink | Recommended (M6) | 3~5 | N·m |
| Torque | Module Terminal | Recommended (M6) | 3~5 | N·m |
| $R_{\theta JC}$ | Thermal Resistance | Junction-to-Case | 0.14 | $^{\circ}\text{C}/\text{W}$ |
| Weight | | | 160 | g |

ELECTRICAL CHARACTERISTICS

T_C=25°C unless otherwise specified

| Symbol | Parameter | Test Conditions | Min. | Typ. | Max. | Unit |
|-------------------|-------------------------------|---|------|------|------|------|
| I _{RM} | Reverse Leakage Current | V _R =1200V | -- | -- | 2 | mA |
| | | V _R =1200V, T _J =125°C | -- | -- | 10 | mA |
| V _F | Forward Voltage | I _F =300A | -- | 2.8 | 3.1 | V |
| | | I _F =300A, T _J =125°C | -- | 2.1 | 2.4 | V |
| t _{rr} | Reverse Recovery Time | I _F =1A, V _R =30V, di _F /dt=-200A/μs | -- | 65 | -- | ns |
| t _{rr} | Reverse Recovery Time | V _R =600V, I _F =300A di _F /dt=-200A/μs, T _J =25°C | -- | 135 | -- | ns |
| I _R RM | Max. Reverse Recovery Current | | -- | 10 | -- | A |
| t _{rr} | Reverse Recovery Time | V _R =600V, I _F =300A di _F /dt=-200A/μs, T _J =125°C | -- | 385 | -- | ns |
| I _R RM | Max. Reverse Recovery Current | | -- | 25 | -- | A |

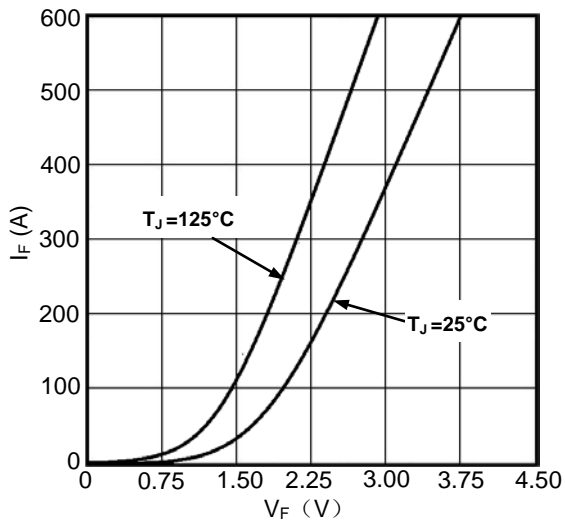

Figure1. Forward Voltage Drop vs Forward Current

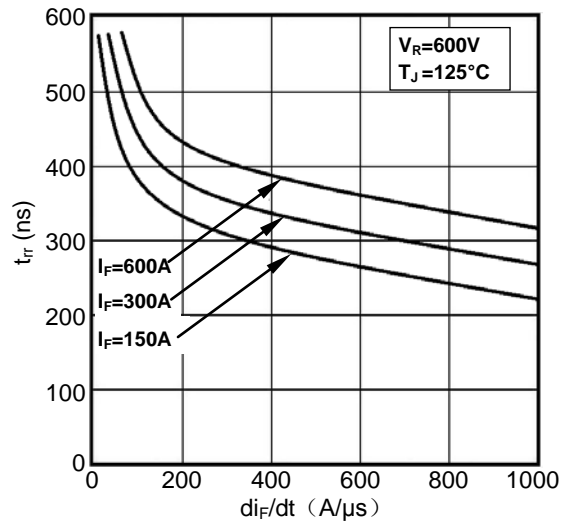

Figure2. Reverse Recovery Time vs di_F/dt

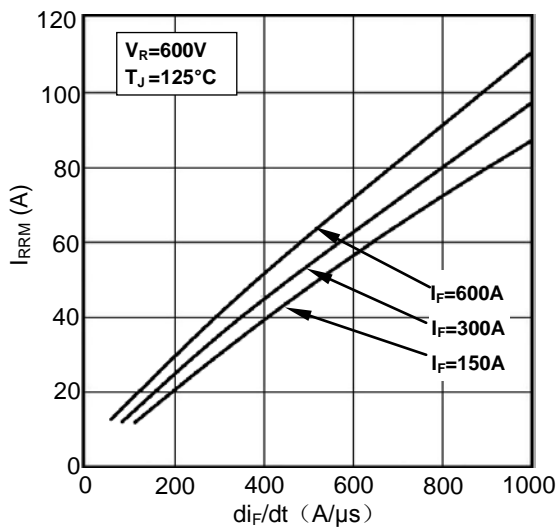

Figure3. Reverse Recovery Current vs di_F/dt

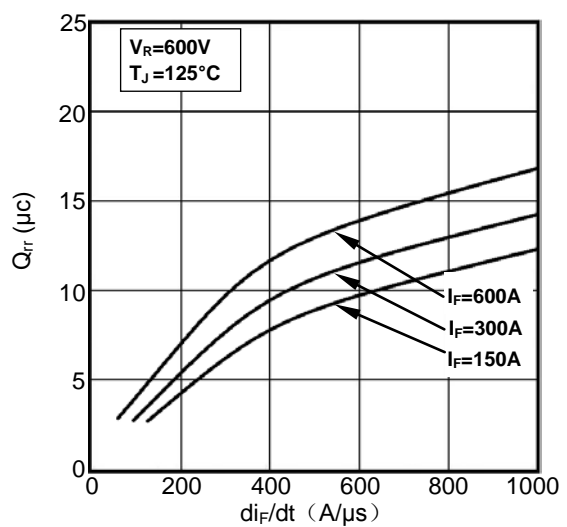

Figure4. Reverse Recovery Charge vs di_F/dt

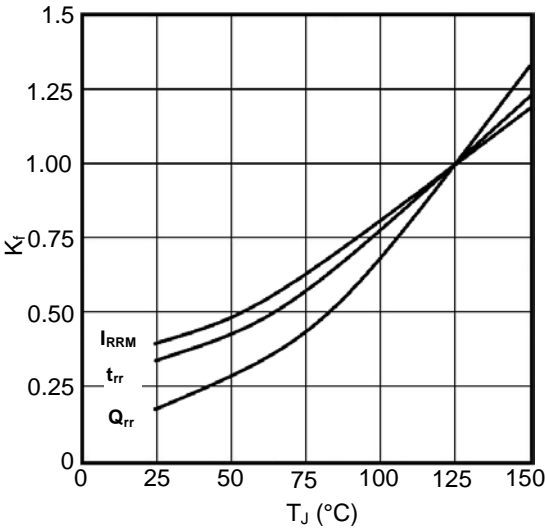

Figure5. Dynamic Parameters vs Junction Temperature

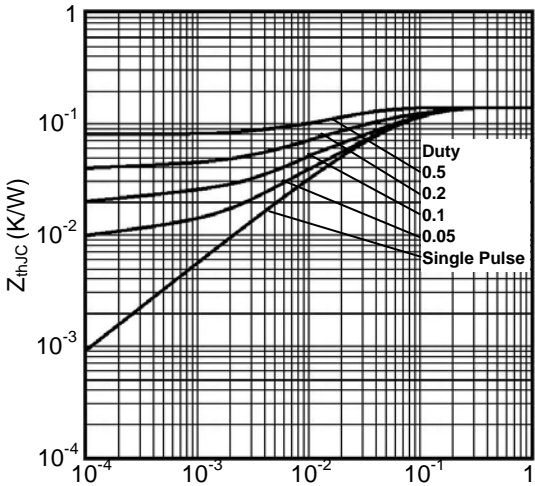
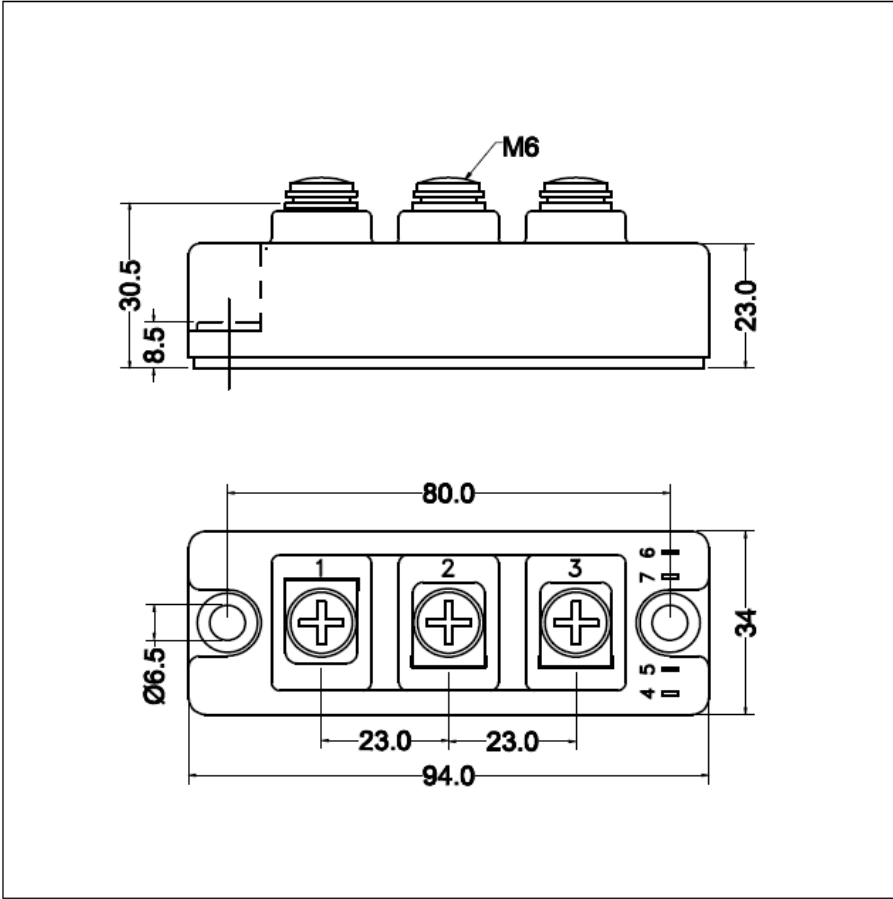

Figure6. Transient Thermal Impedance



Dimensions (mm)
Figure7. Package Outline