

## FEATURES

- Low Forward Voltage
- High Surge Current Capability
- Low Leakage Current
- Low Inductance Package

## APPLICATIONS

- Field Supply For DC Motors
- Line Rectifiers For Transistorized AC Motor Controllers
- Non-controllable Rectifiers For AC/DC Converter

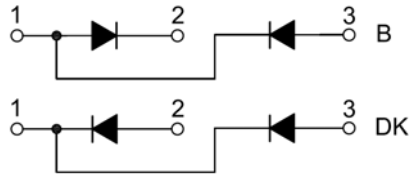

## MODULE TYPE

TYPE	Circuit Diagram		VRRM (Repetitive Peak Reverse Voltage)	VRSM (Non-Repetitive Peak Reverse Voltage)	Unit
	B	DK			
MMD60A120B	MMD60A120DK	1200	1300	V	
MMD60A140B	MMD60A140DK	1400	1500		
MMD60A160B	MMD60A160DK	1600	1700		
MMD60A180B	MMD60A180DK	1800	1900		

## ABSOLUTE MAXIMUM RATINGS

*T<sub>c</sub>=25°C unless otherwise specified*

Symbol	Parameter	Test Conditions	Values	Unit
I <sub>F(AV)</sub>	Average Forward Current	Single phase, half wave, 180°conduction, T <sub>c</sub> = 90°C	60	A
I <sub>F(RMS)</sub>	R.M.S. Forward Current		94	
I <sub>FSM</sub>	Non-Repetitive Surge Forward Current	1/2 cycle, 50HZ, peak value T <sub>c</sub> =45°C	1350	
		1/2 cycle, 60HZ, peak value T <sub>c</sub> =45°C	1450	
I <sup>2</sup> t	I <sup>2</sup> t (For Fusing)	1/2 cycle, 50HZ, peak value T <sub>c</sub> =45°C	9.1	KA <sup>2</sup> s
		1/2 cycle, 60HZ, peak value T <sub>c</sub> =45°C	8.7	KA <sup>2</sup> s
P <sub>D</sub>	Power Dissipation		195	W
T <sub>J</sub>	Junction Temperature		-40 to +150	°C
T <sub>STG</sub>	Storage Temperature Range		-40 to +125	°C
V <sub>ISO</sub>	Isolation Breakdown Voltage	AC, 50Hz(R.M.S), t=1minute	3000	V
Torque	Module-to-Sink	Recommended (M6)	3~5	N.m
Torque	Module Electrodes	Recommended (M5)	2.5~5	N.m
R <sub>th (J-C)</sub>	Junction-to-Case Thermal Resistance		0.63	K /W
Weight			110	g

# MMD60A

## ELECTRICAL AND THERMAL CHARACTERISTICS $T_C=25^\circ\text{C}$ unless otherwise specified

Symbol	Parameter	Test Conditions	Min.	Typ.	Max.	Unit
$I_{RM}$	Max.Reverse Leakage Current	$V_R = V_{RRM}$			500	$\mu\text{A}$
		$V_R = V_{RRM}, T_J = 125^\circ\text{C}$			10	mA
$V_F$	Forward Voltage	$I_F = 180\text{A}$			1.5	V
$V_{T0}$	For power-loss calculations only				0.85	V
$r_T$	$T_J = 125^\circ\text{C}$				3.6	m $\Omega$

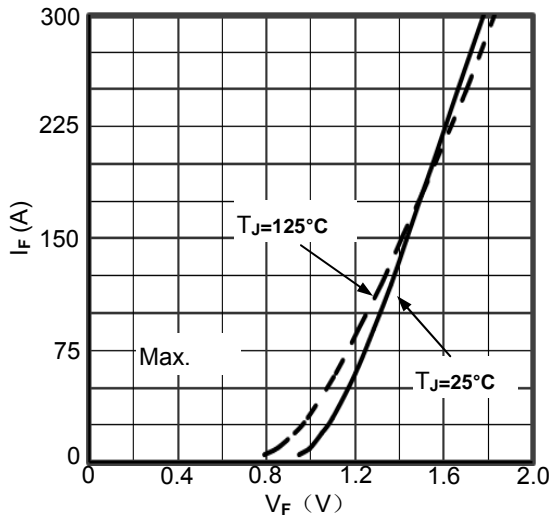

Figure1. Forward current vs.voltage drop

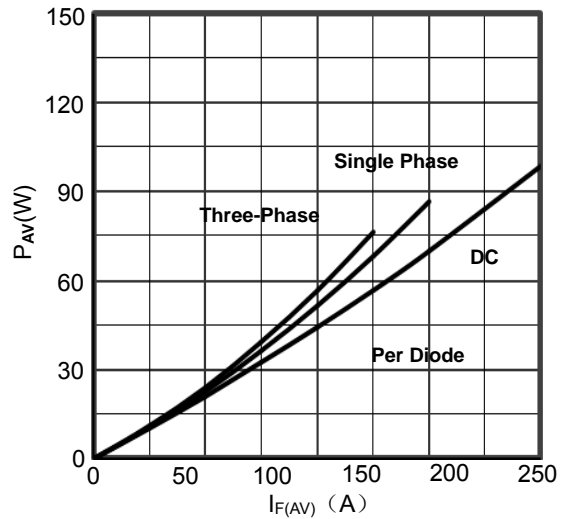

Figure2. Diode Power dissipation vs.  $I_{F(AV)}$

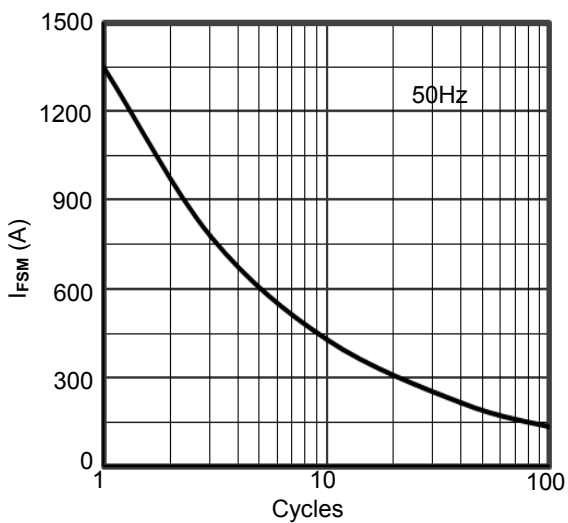

Figure3. Max Non-Repetitive Forward Surge Current

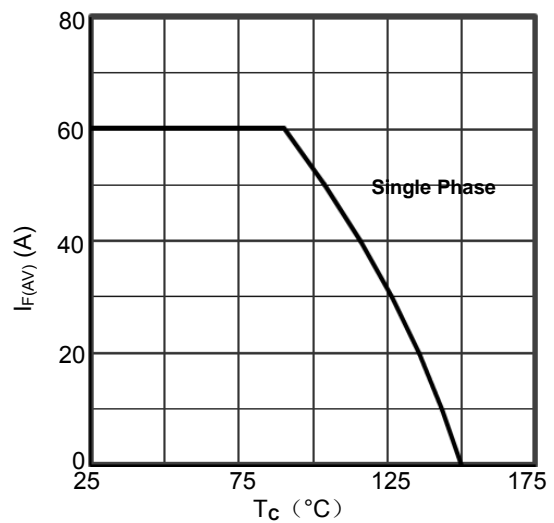

Figure4. Forward current vs. Case temperature

**MMD60A**

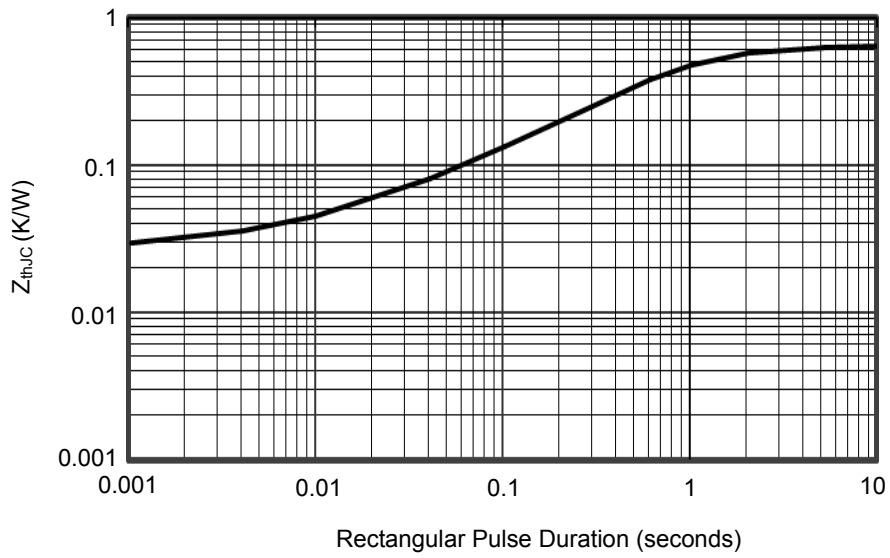
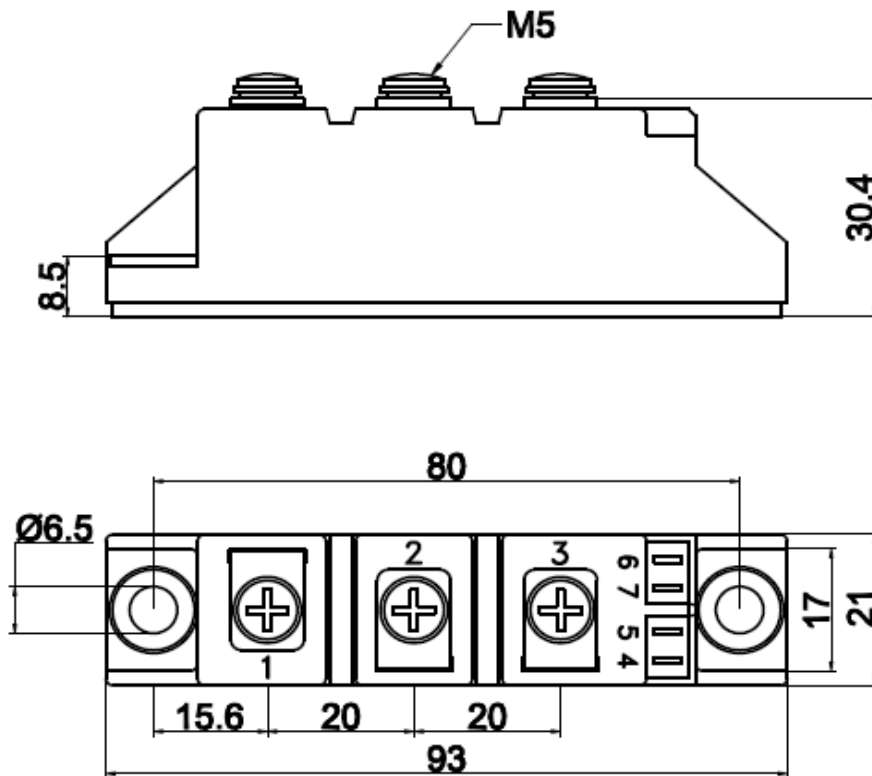

Figure5. Transient Thermal Impedance



Dimensions in Millimeters and (Inchs)  
Figure6. Package Outline