

PRODUCT FEATURES

- Proprietary New Trench Technology
- $R_{DS(ON),typ}=6.2m\Omega@V_{GS}=10V$
- Low Gate Charge Minimize Switching Loss
- Fast Recovery body Diode

APPLICATIONS

- High efficiency DC/DC Converters
- Synchronous Rectification
- UPS inverter

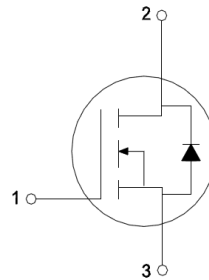

1.GATE
2.DRAIN
3.SOURCE

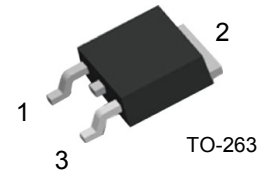
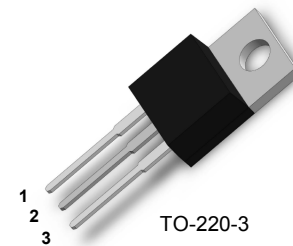

Type	V_{DS}	I_D	$R_{DS(ON),max} T_J=25^\circ C$	T_{Jmax}	Marking	Package
MM3205K	65V	91	8.0m Ω	175 $^\circ C$	MM3205K	TO-220
MM3205S	65V	91	8.0m Ω	175 $^\circ C$	MM3205S	TO-263

ABSOLUTE MAXIMUM RATINGS

$T_C=25^\circ C$ unless otherwise specified

Symbol	Parameter/Test Conditions	Values	Unit	
V_{DSS}	Drain Source Voltage	$T_J=25^\circ C$ 65	V	
V_{GSS}	Gate Source Voltage	± 20		
I_D	Continuous Drain Current	$T_C=25^\circ C$ (Silicon limited)	91 ^①	
		$T_C=100^\circ C$ (Silicon limited)	64	
I_{DM}	Pulsed Drain Current at $V_{GS}=10V$	Limited by T_{Jmax}	413	
P_D	Maximum Power Dissipation	157	W	
E_{AS}	Single Pulse Avalanche Energy ($V_{DD}=50V, L=1mH$)	448	mJ	
T_{Jmax}	Max. Junction Temperature	175	$^\circ C$	
T_{STG}	Storage Temperature Range	-55~175		
Torque	Module to Sink (TO-220)	Recommended (M3)	1.1	Nm
Weight			2.5	g

① Calculated continuous current based on maximum allowable junction temperature. Package limitation current is 80A.

THERMAL CHARACTERISTICS

$T_C=25^\circ C$ unless otherwise specified

Symbol	Parameter/Test Conditions	Values	Unit
R_{thJC}	Thermal resistance, junction to case	0.95	$^\circ C/W$
R_{thJA}	Thermal resistance, junction to ambient	62	

ELECTRICAL CHARACTERISTICS

 $T_C = 25^\circ\text{C}$ unless otherwise specified

Symbol	Parameter/Test Conditions		Min.	Typ.	Max.	Unit
$V_{(BR)DSS}$	Drain Source Breakdown Voltage	$V_{GS}=0V, I_D=250\mu A$	65			V
$R_{DS(ON)}$	Drain Source ON Resistance	$V_{GS}=10V, I_D=62A$		6.2	8	m Ω
I_{DSS}	Drain Source Leakage Current	$V_{DS}=65V, V_{GS}=0V$			25	μA
$V_{GS(th)}$	Gate Threshold Voltage	$V_{GS}=V_{DS}, I_D=250\mu A$	2.0		4.0	V
I_{GSS}	Gate Leakage Current	$V_{DS}=0V, V_{GS}=\pm 20V$	-100		100	nA
R_{gint}	Integrated Gate Resistor			4		Ω
Q_g	Total Gate Charge	$V_{DD}=44V, I_D=62A, V_{GS}=10V$		71		nC
Q_{gs}	Gate Source Charge			25		nC
Q_{gd}	Gate Drain Charge			17.5		nC
g_{fs}	Forward Transconductance	$V_{DS}=10V, I_D=62A$		TBD		S
C_{iss}	Input Capacitance	$V_{DS}=25V, V_{GS}=0V, f=1\text{MHz}$		2.9		nF
C_{oss}	Output Capacitance			320		pF
C_{rss}	Reverse Transfer Capacitance			120		pF
$t_{d(on)}$	Turn on Delay Time	$V_{DD}=28V, I_D=62A,$ $R_G=5\Omega, V_{GS}=10V$	$T_J=25^\circ\text{C}$		42	ns
t_r	Rise Time				190	ns
$t_{d(off)}$	Turn off Delay Time				156	ns
t_f	Fall Time				60	ns

Source-Drain BODY-DIODE CHARACTERISTICS

 $T_C = 25^\circ\text{C}$ unless otherwise specified

Symbol	Parameter/Test Conditions		Min.	Typ.	Max.	Unit
I_{SD}	Continuous Source Drain Current				91	A
I_{SDM}	Pulse Source Drain Current	Limited by T_{Jmax}			413	A
V_{SD}	Forward Voltage	$I_S=62A, V_{GS}=0V$			1.2	V
t_{rr}	Reverse Recovery time	$I_F=62A, V_{GS}=0V$		105		ns
Q_{RR}	Reverse Recovery Charge	$di_F/dt=-100A/\mu s$		310		nC

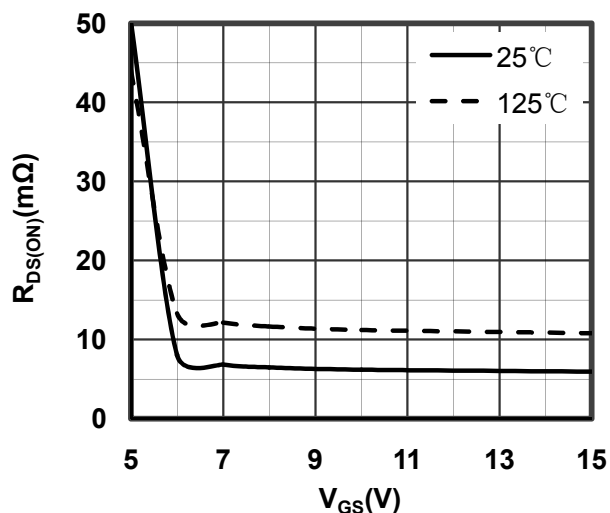

Figure 1. Typical $R_{DS(ON)}$ vs Gate Voltage

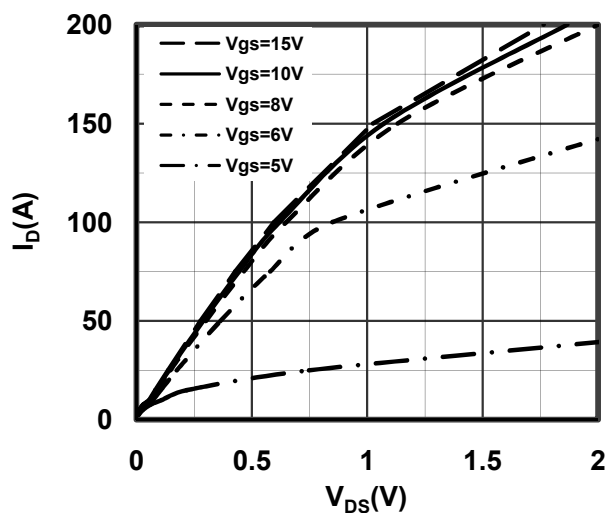

Figure 2. Typical Output Characteristics

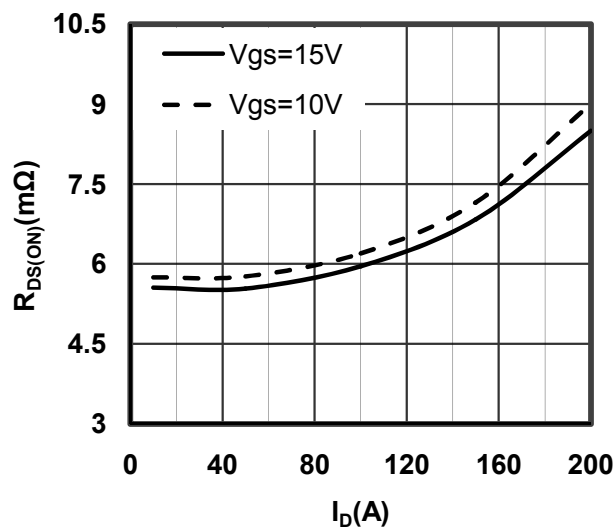

Figure 3. Drain-Source ON Resistance vs I_D

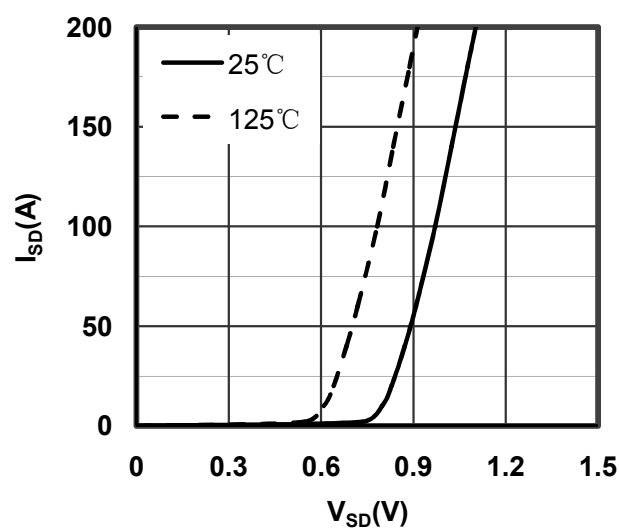

Figure 4. Source-Drain Voltage

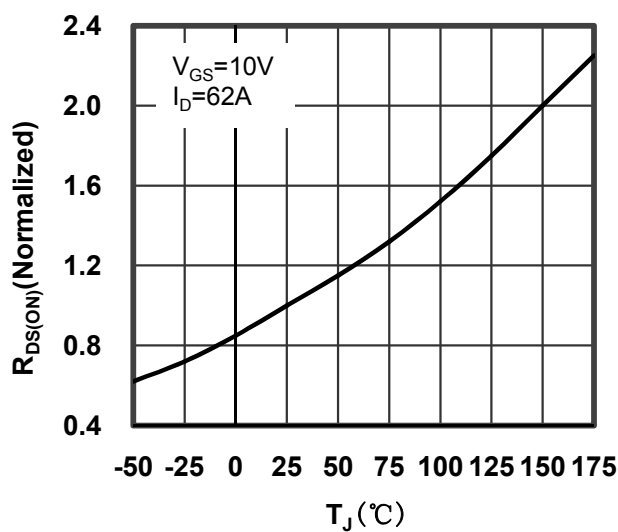

Figure 5. Drain-Source ON Resistance vs Junction Temperature

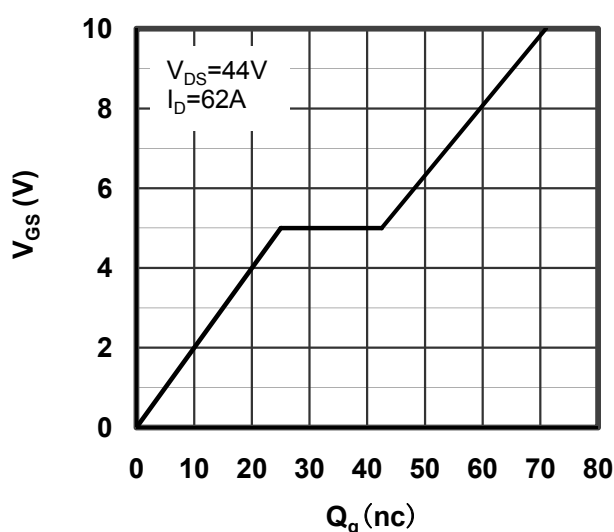

Figure 6. Gate Charge characteristics

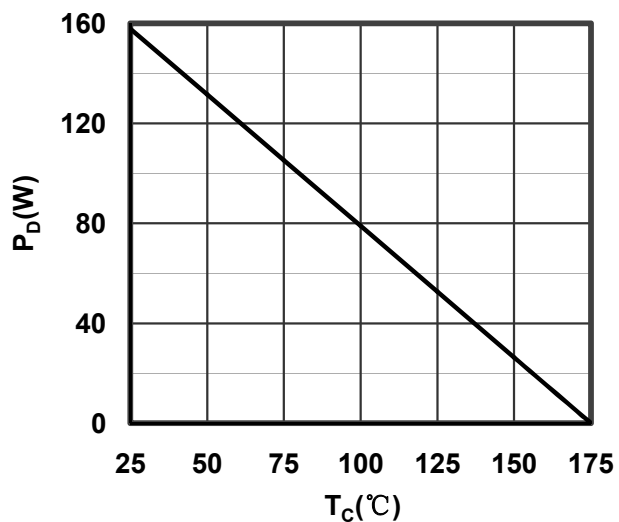

Figure 7. Maximum Power Dissipation vs Case Temperature

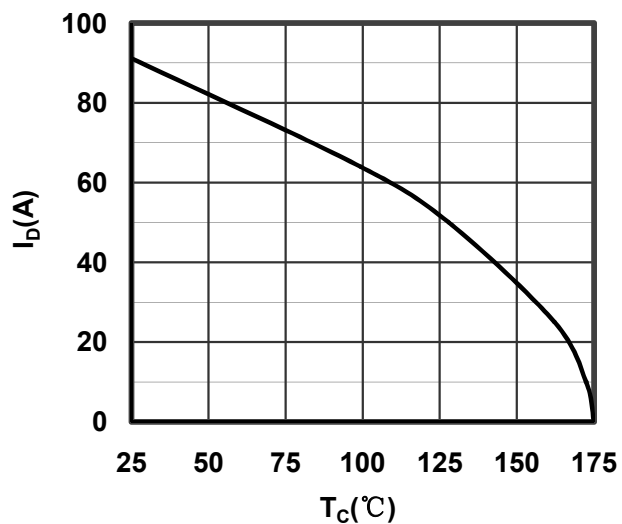

Figure 8. Maximum Continuous Drain Current vs Case Temperature

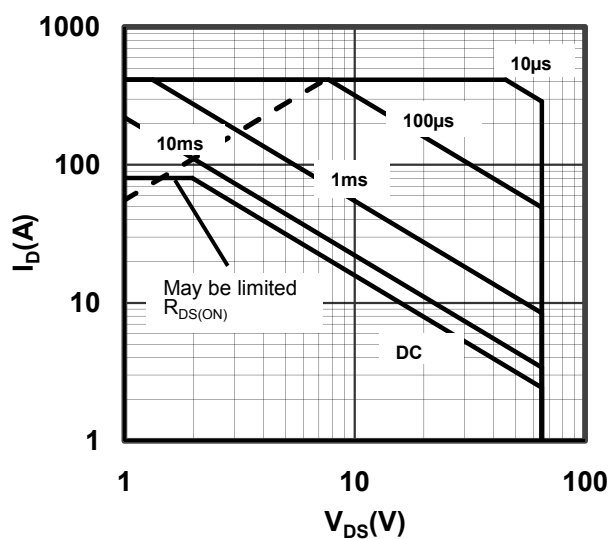

Figure 9. Maximum Forward Safe Operation Area

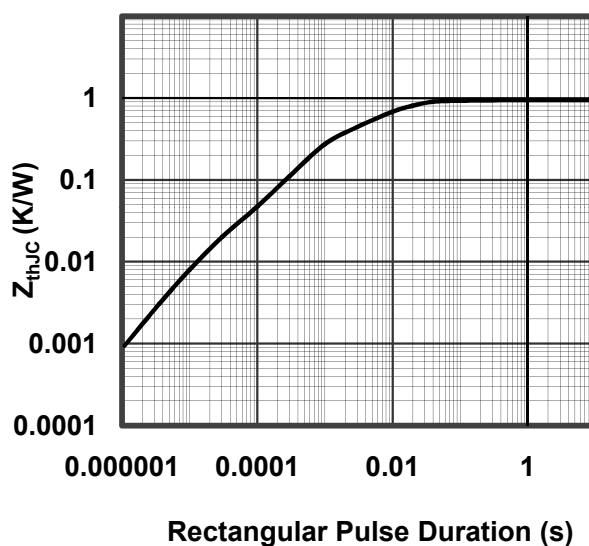
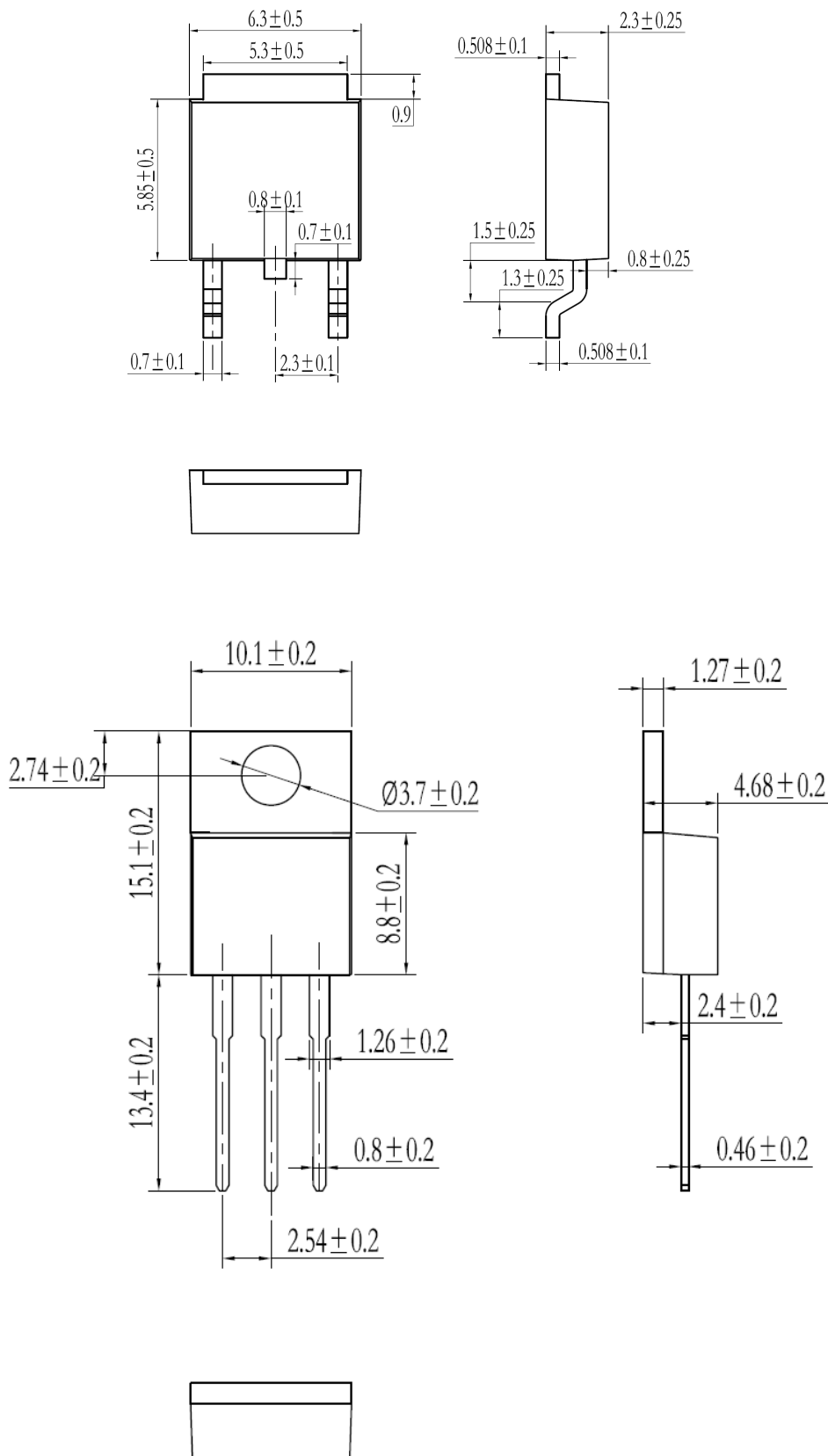

Figure 10. Transient Thermal Impedance



Dimensions in (mm)
Figure 11. Package Outline