

PRODUCT FEATURES

- Ultrafast Recovery Time
- Low Recovery Loss
- Soft Reverse Recovery Characteristics
- Low Leakage Current
- Low Forward Voltage
- High Surge Current Capability

APPLICATIONS

- Freewheeling, Snubber, Clamp
- Inversion Welder
- PFC
- Plating Power Supply
- Ultrasonic Cleaner and Welder
- Converter & Chopper
- UPS

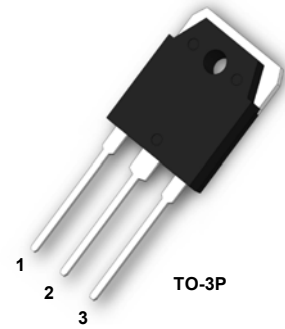

DESCRIPTION

FRED from MacMic utilizes advanced processing techniques to achieve ultrafast recovery times and higher forward current. Its soft recovery characteristics and high reliability suit for wide industrial applications.

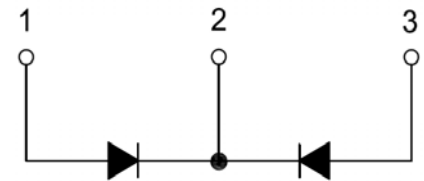

ABSOLUTE MAXIMUM RATINGS

$T_C=25^\circ\text{C}$ unless otherwise specified

Symbol	Parameter/Test Conditions		Values	Unit
V_R	Maximum D.C. Reverse Voltage		100	V
V_{RRM}	Maximum Repetitive Reverse Voltage			
$I_{F(AV)}$	Average Forward Current	$T_C=110^\circ\text{C}$, Per Diode	15	A
		$T_C=110^\circ\text{C}$, Per Package	30	
$I_{F(RMS)}$	RMS Forward Current	$T_C=110^\circ\text{C}$, Per Diode	21	
I_{FSM}	Non-Repetitive Surge Forward Current	$T_J=45^\circ\text{C}$, $t=10\text{ms}$, 50Hz, Sine	180	
P_D	Power Dissipation		83	W
T_J	Junction Temperature		-55 to +150	$^\circ\text{C}$
T_{STG}	Storage Temperature Range		-55 to +150	$^\circ\text{C}$
Torque	Module-to-Sink	Recommended (M3)	1.1	N.m
$R_{\theta JC}$	Junction-to-Case Thermal Resistance		1.5	$^\circ\text{C}/\text{W}$
Weight			6	g

ELECTRICAL CHARACTERISTICS

$T_C=25^\circ\text{C}$ unless otherwise specified

Symbol	Parameter/Test Conditions		Min.	Typ.	Max.	Unit
I_{RM}	Maximum Reverse Leakage Current	$V_R = 100\text{V}$			10	μA
		$V_R = 100\text{V}$, $T_J = 125^\circ\text{C}$			10	mA
V_F	Forward Voltage	$I_F=15\text{A}$ Per Diode		0.86	1.00	V
		$I_F=15\text{A}$, $T_J=125^\circ\text{C}$ Per Diode		0.75		
t_{rr}	Reverse Recovery Time ($I_F = 1\text{A}$, $diF/dt = -200\text{A}/\mu\text{s}$, $V_R = 30\text{V}$)			19	23	ns
t_{rr}	Reverse Recovery Time			23		ns
I_{RRM}	Maximum Reverse Recovery Current			3.4		A
t_{rr}	Reverse Recovery Time			37		ns
I_{RRM}	Maximum Reverse Recovery Current			5.7		A

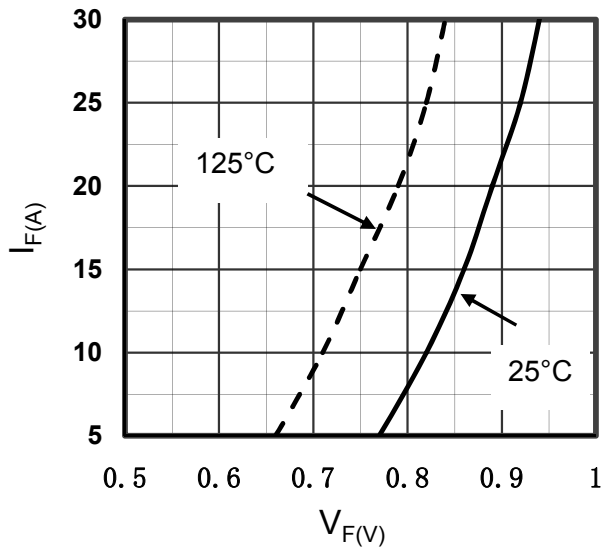

Figure1. Forward Voltage Drop vs Forward Current

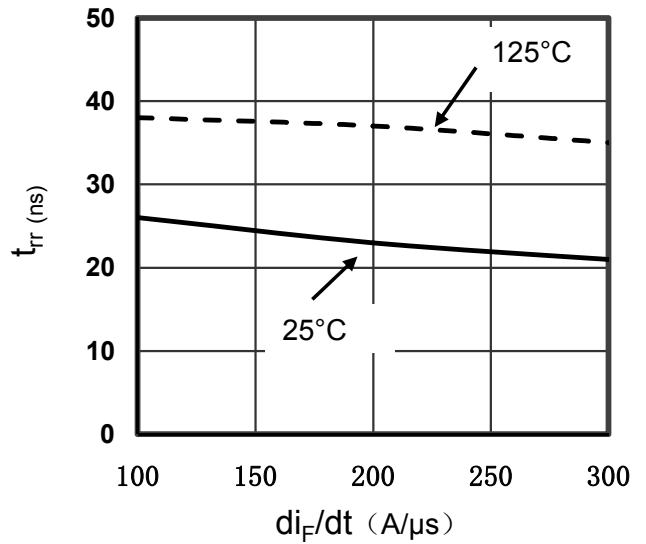

Figure2. Reverse Recovery Time vs diF/dt

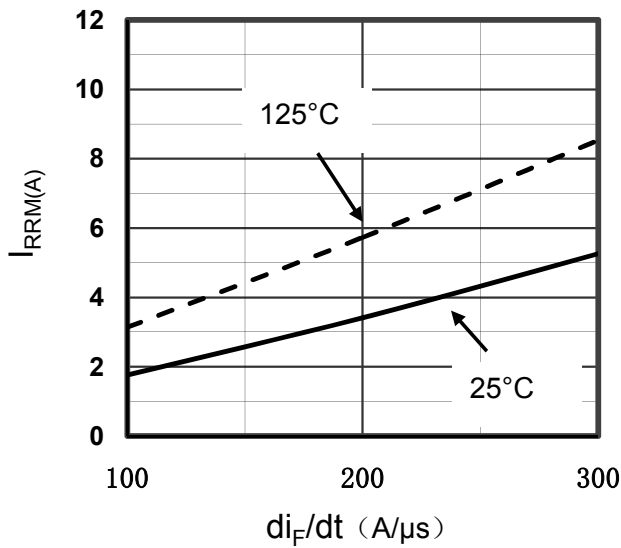

Figure3. Reverse Recovery Current vs diF/dt

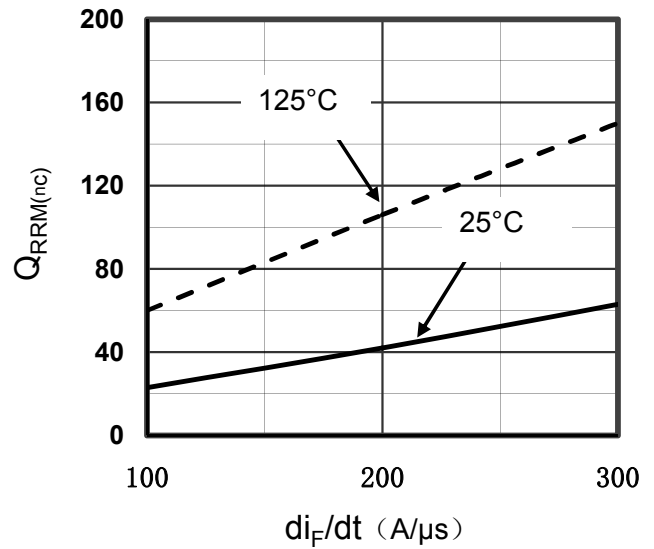

Figure4. Reverse Recovery Charge vs diF/dt

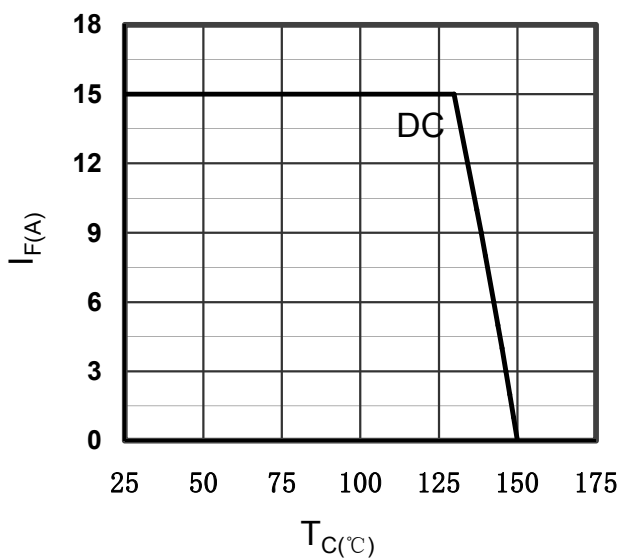

Figure5. Forward current vs Case temperature

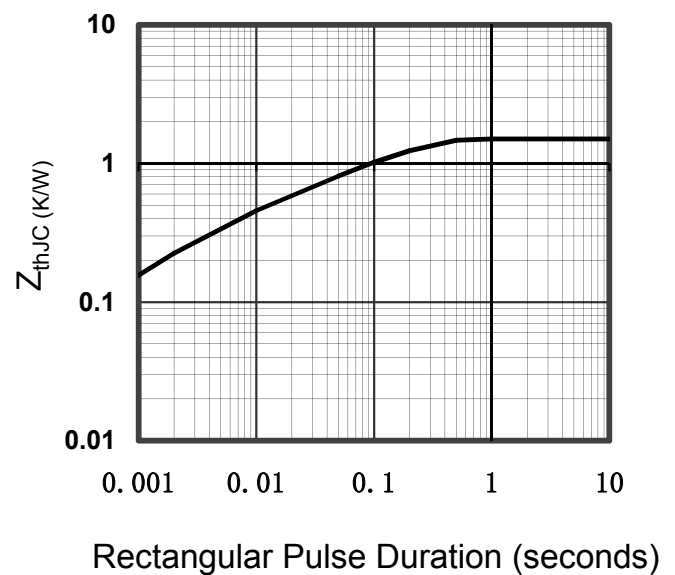

Figure6. Transient Thermal Impedance₂

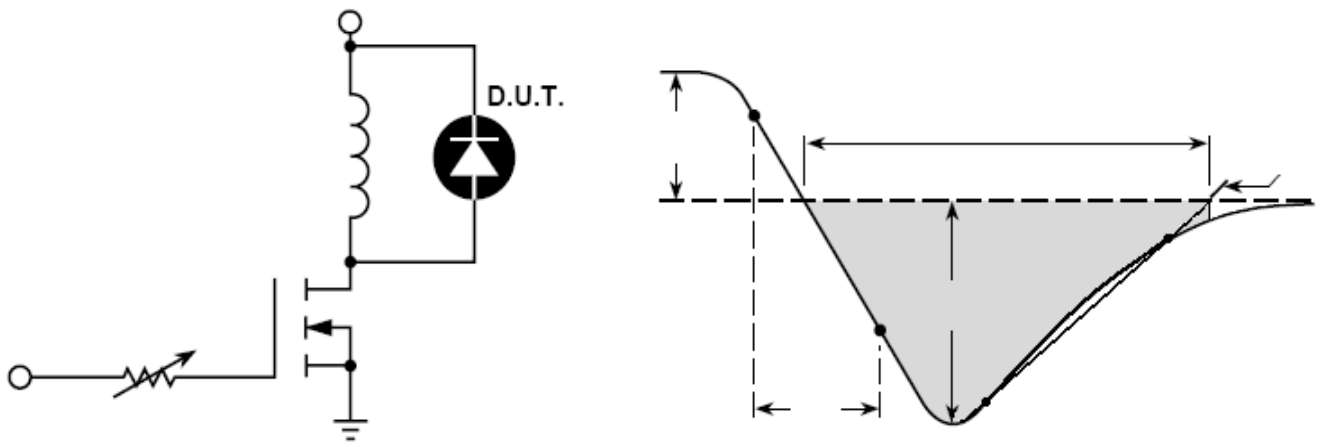
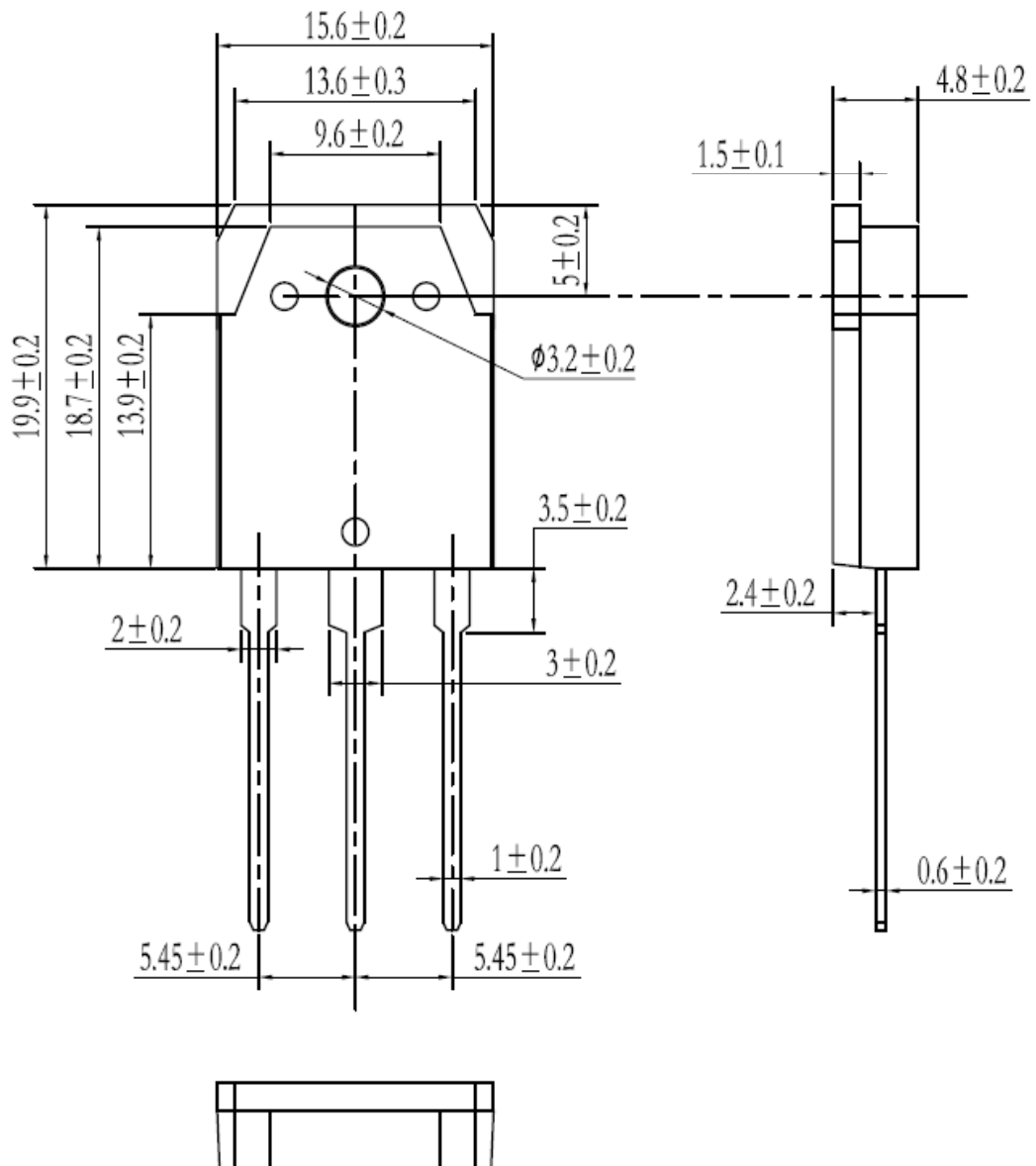

Figure7. Diode Reverse Recovery Test Circuit and Waveform



Dimensions in Millimeters
Figure8. Package Outline